

D-2

LA-2412

LOS ALAMOS SCIENTIFIC LABORATORY
OF THE UNIVERSITY OF CALIFORNIA ○ LOS ALAMOS NEW MEXICO

DYNAMICS OF COMPRESSIBLE FLUIDS

T. C. ...
(1) ...
(2) ...

Reproduced From
Best Available Copy

20000920 204

DISTRIBUTION STATEMENT A
Approved for Public Release
Distribution Unlimited

LEGAL NOTICE

This report was prepared as an account of Government sponsored work. Neither the United States, nor the Commission, nor any person acting on behalf of the Commission:

A. Makes any warranty or representation, expressed or implied, with respect to the accuracy, completeness, or usefulness of the information contained in this report, or that the use of any information, apparatus, method, or process disclosed in this report may not infringe privately owned rights; or

B. Assumes any liabilities with respect to the use of, or for damages resulting from the use of any information, apparatus, method, or process disclosed in this report.

As used in the above, "person acting on behalf of the Commission" includes any employee or contractor of the Commission, or employee of such contractor, to the extent that such employee or contractor of the Commission, or employee of such contractor prepares, disseminates, or provides access to, any information pursuant to his employment or contract with the Commission, or his employment with such contractor.

Printed in USA. ~~Price \$ 0.00~~. Available from the
Office of Technical Services
U. S. Department of Commerce
Washington 25, D. C.

LA-2412
PHYSICS AND MATHEMATICS
TID-4500, 15th Ed.

LOS ALAMOS SCIENTIFIC LABORATORY
OF THE UNIVERSITY OF CALIFORNIA LOS ALAMOS NEW MEXICO

REPORT WRITTEN: April 1960

REPORT DISTRIBUTED: November 18, 1960

DYNAMICS OF COMPRESSIBLE FLUIDS

by

Francis H. Harlow

This report expresses the opinions of the author or authors and does not necessarily reflect the opinions or views of the Los Alamos Scientific Laboratory.

Contract W-7405-ENG. 36 with the U. S. Atomic Energy Commission

ABSTRACT

A compilation has been made of numerous topics in the theory of compressible-fluid dynamics. The presentation is designed as a guide for students as well as a source of reference material for the research worker. The choice of material has been influenced by the needs and projects at the Los Alamos Scientific Laboratory, where much of the theoretical work in fluid dynamics is carried out by numerical techniques on high-speed electronic computers. There is, however, no discussion of the numerical methods themselves.

CONTENTS

	Page
Abstract	3
Introduction	7
Chapter I. The Basic Equations	13
Introduction	13
Characterization of the Fluid	15
One-Dimensional Flow	17
Conservation of Mass	17
Conservation of Momentum	19
Conservation of Energy	20
Lagrangian Form of the Equations	21
Time Derivatives of a Volume Integral	26
One-Dimensional Conservative Form	28
Other Coordinate Systems	31
Equation of State	34
The Equations for a Fluid with Nonlocal Forces	35
Chapter II. Discussion of the Equations	39
The Polytropic Equation of State	39
Changes of State in a Simple Gas	41
Angular Velocity and Circulation	44
Angular Momentum	49
Local Decomposition of the Velocity Field	51
Propagation of Small Disturbances	53
Sound Waves in a Variable-Density Atmosphere	55
Chapter III. Characteristic Solutions and Simple Waves	58
Characteristics	58
Simple Waves	63
Chapter IV. Shocks	70
Description of a Shock	70
Fundamental Derivation of the Shock Relations	72
Integral Derivation of the Shock Relations	73
Discussion of Shock Formation	75
Shock Relations for Special Cases	77
Entropy Change Across a Shock	81
Hugoniot Relation	82

CONTENTS (Continued)

Chapter V. Dimensionality and Similarity	84
Scaling	84
Similarity	86
Chapter VI. Decay of a Shock Pulse	91
General Discussion	91
Decay of a Very Strong, Impulsively-Formed Shock Pulse	92
Interaction of a Rarefaction Overtaking a Weak Shock	102
Chapter VII. Inverted Hydrodynamic Equations	106
The Transformation	106
Example: Expansion into a Vacuum	111
Chapter VIII. Theory of Viscosity	113
General Description	113
Formulation from the Diffusion Viewpoint	115
The Energy Equation	120
Dilatative Dissipation	123
Discussion of the Dilatation Pressure	124
Introduction to Rigorous Viscosity Theory	127
Chapter IX. Examples of Viscous and Conducting Flows	138
The Equations Specialized	138
Diffusion of the Viscous Effect	140
Two Steady-State Solutions	144
Finite Thickness of Shocks	148
Sound Waves in a Viscous, Conducting Gas	154
Very Large Conductivity	157
Chapter X. Some Special Problems	162
Problem 1. Flow Past a Wedge	162
Problem 2. The Shock Tube	165
Problem 3. Shock Hitting a Density Discontinuity	169
Problem 4. The Reactive Shock or Detonation	176
Problem 5. Steady Flow Around a Sharp Corner	181
Problem 6. Instability of Interface Between Fluids	187
Taylor Instability, Fluid Incompressible	188
Combined Helmholtz and Taylor Instabilities	191
Index	196

INTRODUCTION

The major emphasis in fluid-dynamics studies has gradually shifted over the last few years. During the early days of aircraft almost all processes of interest took place at speeds far less than that of sound. Fluids could therefore be treated as incompressible, or, as having a density which varied with time or space only, generally in a predetermined manner. As aircraft speeds increased, other high-speed phenomena became of interest, and assumption of an incompressible fluid was no longer valid for many practical situations. As a result, new analytical techniques were developed and applied to a variety of design problems, especially in aerodynamics.

Meanwhile, interest has grown in the dynamics of fluids adjacent to high-intensity explosions, and in the theoretical techniques necessary for understanding the processes involved. The complexity of the analysis has often required a change in the theoretical approach from analytical to numerical. At Los Alamos, various numerical methods have been evolved and applied by means of high-speed electronic computers. As a background for this work, it has been necessary to gather from numerous parts of the literature analytical techniques by which solutions could be obtained for comparison with the numerical results.

INTRODUCTION

The analytical methods sometimes required extension, modification, or reinterpretation, or new techniques had to be developed. It is the purpose of this manual to present this analytical material in the hope that it will be a useful background to others whose compressible-fluid problems are similar to ours.

This compilation is for reference as well as teaching. It thus contains many detailed and alternative formulations which may at first confuse the beginner; but at the same time it omits certain types of elegant argument for which reference to original papers is more appropriate. The student interested in further details can profit from several excellent books;* these have often served as basic references herein.

It is suggested that the student read quickly the first four chapters of this manual and any subsequent sections of special interest, and then return to the earlier chapters for detailed study or reference as the need arises. The newcomer to fluid dynamics will find it useful to have a qualitative feeling for the phenomena involved, before proceeding to the details of formulation. The rest of this Introduction offers such a qualitative picture.

*These include:

Richard Courant and K. D. Friedrichs, "Supersonic Flow and Shock Waves," Interscience Publishing Company, New York, 1948.

R. von Mises, "Mathematical Theory of Compressible Fluid Flow," Academic Press, Inc., New York, 1958.

L. D. Landau and E. M. Lifshitz, "Fluid Mechanics," Pergamon Press, Ltd., London; Addison-Wesley Publishing Company, Inc., Reading, Mass; 1959.

INTRODUCTION

The first thing that is needed in a theoretical treatment of fluid dynamics is a means for characterizing the fluid. Thus, for example, if we have material in a box and wish to examine the dynamics of it, then it is necessary to specify certain field variables and try to determine the manner in which they change with time. Such field variables include mass density, velocity of each part of the fluid, pressure, internal energy, temperature, and various other similar quantities. We shall attempt to define these quantities in the following chapters but will here proceed on the basis of our intuition of their meaning.

To describe how these quantities change with time from a given initial configuration, subject to prescribed conditions at the boundary of the fluid, we must derive a set of governing equations. One of these will be a statement of the characteristics of the fluid itself, the "equation of state" which describes in mathematical terms the relationship, at any given instance and place, among such quantities as temperature, density, and pressure. If the material is a simple gas, then the form of the equation may be quite simple, but if the material is anything else, then the relationship may be extremely complicated or even impossible to write in analytical form.

Concerning the dynamics of the gas itself, we shall show that all processes take place according to the dictates of the three fundamental conservation laws of physics, namely, those of mass, momentum, and energy.

It is useful to examine the motion of a fluid from at least two fundamentally different points of view. In one case the coordinate

INTRODUCTION

system will be fixed relative to the observer, while in the other the coordinate system is considered to follow the motion of the fluid. The former viewpoint is called Eulerian; the latter is called Lagrangian. The nature of the problem will dictate which form of the equations will be more desirable.

For many applications it is reasonable to neglect the effects of heat conduction and viscosity. As a result there are two rather remarkable consequences. The first of these is that the entropy of each element of the fluid remains forever constant. The second is that the equations may lead to discontinuous solutions even if the initial and boundary conditions are apparently very well behaved. The constancy of entropy is discussed in some detail in Chapter II. The treatment of discontinuity will receive much attention in many parts of the manual.

The mathematical discontinuities are called "shocks." Their behavior is not governed by the differential equations, which become meaningless at a discontinuity; but properly treated, the mathematically discontinuous shock is useful because it closely represents a true phenomenon in which such quantities as density, pressure, and velocity may change very rapidly over a very small distance.

The equations that are derived in Chapter I show that weak signals are propagated through a fluid with a certain characteristic velocity called the "sound speed." The sound speed will be shown to vary with temperature and density in a manner which depends upon the equation of state of the fluid. Generally, with an increase in temperature and den-

INTRODUCTION

sity, the sound speed goes up. Thus, if a compressive signal is formed by a piston pushing into a gas, the gas near the piston is compressed and heated so that the sound speed is increased above that which is ahead of the disturbance. As the piston velocity increases, sound signals begin to pile up on one another, and the front of the disturbance wave becomes sharper and sharper. This produces a shock. If, on the other hand, the piston is withdrawn from the gas, then the sound speed adjacent to the piston goes down because of the expansive temperature decrease, and signals from the piston are not able to overtake the disturbance front moving into the fluid. The piston motion forms a rarefaction and no discontinuity occurs in the fluid. We shall later demonstrate more precisely the fact that shocks are formed only at the fronts of compressive waves.

The two basic elements of fluid flow, shock and rarefaction, will prove to be the basic building stones for many useful analytical solutions. We shall see, however, that it is seldom possible to solve the equations simply, because they are nonlinear partial differential equations which lack the powerful solution techniques available for linear equations. Instead we shall often have to generate solutions to problems by a careful piecing together of known parts of solutions; many of the examples in this manual have been formed in that way.

Almost all theoretical treatments of fluid dynamics are based on the model of a continuous fluid whose elements remain forever contiguous. In reality, a fluid is formed of numerous molecules which may rapidly

INTRODUCTION

move about so that neighboring particles at one instant may be widely separated a short time later. It may thus seem remarkable that the simplified model gives useful results at all. In Chapter VIII we have indicated how the success of the continuous model can be explained, and also have shown how the failings of the continuous model can be remedied somewhat by inclusion of the effects of viscosity and heat conduction. In the continuous model, viscosity is interpreted as a drag stress, whereas in reality it arises from diffusion across velocity gradients. The equations with viscosity and heat conduction do not tend to give discontinuous solutions; indeed the detailed structure of a shock can be derived, and the results agree closely with experimental measurements.

These qualitative features are illustrated in this manual by giving solutions to numerous problems. In this way, the reader learns that some situations in fluid dynamics are easily analysed; he will also quickly realize, as he tries additional problems, that there are many apparently simple situations for which analytical solutions are presently impossible.

The progress of this manual has profited considerably from a careful study of the entire manuscript by Cyril Hirt, from a detailed checking of several sections by Jacob Fromm, and from numerous discussions with my associates. The hard jobs of editing the raw manuscript, removing the numerous inconsistencies in nomenclature, adding a coherence of style among the chapters, and tending to numerous details leading to the final form, all with exceptional care beyond the call of duty were accomplished by Marion Richardson. Readability of the final form owes much to the patient and careful typing of Grace Cole.

CHAPTER I
THE BASIC EQUATIONS

Introduction

By popular concept, a fluid is a mobile substance into which a solid object can be immersed with ease but which does not sustain the deformation when the object is removed. More precisely, a fluid may be defined as a material for which the stress produced by a shearing strain is independent of the strain. This definition does not exclude those materials for which the stress depends upon the rate of shearing strain; such fluids are called viscous.

No precise description of the dynamics of any macroscopic section of fluid is ever likely to be possible; such a description would involve the exact history of every molecule. There are, however, numerous situations in which theoretical results of high accuracy can be obtained without such detailed knowledge.

The first basic requirement for any theoretical study of fluid dynamics is a means for characterizing the macroscopic features of the fluid. The second requirement is a formulation of the dynamical problem itself. In this chapter, we describe these for rather idealized fluids, namely, for those in which the effects of viscosity and heat conduction are

I. THE BASIC EQUATIONS

negligible, and for which there is no internal source of energy (as would arise, for example, from chemical reactions). We shall call such a fluid a "simple fluid;" likewise, we shall often refer to a "simple gas." In spite of these idealizations, the resulting equations will be very useful for describing quite accurately numerous problems of dynamics.

We shall be limited to those situations in which the fluid can be considered as macroscopically continuous. A rigorous discussion of the circumstances under which this is possible is beyond the scope of this manual; however, we can formulate the conditions loosely as follows. Consider that the space occupied by the fluid is divided into numerous subregions. For each subregion, the instantaneous values of various appropriate quantities are averaged over all the contained molecules. Then the fluid is continuous, for our purposes, provided that for all quantities of interest a set of subregions can be found such that the inter-subregion variations of the averages are, at every instant of time, negligibly small compared with the averages themselves. This requirement implies the following features:

1. Each subregion is large enough to contain a large number of molecules.
2. Each subregion is small compared with any macroscopic feature of the gross configuration.

With the continuity requirement satisfied, the true fluid can now be replaced by an appropriate continuous model. This substitution can be accomplished by the use of some suitable interpolation method applied

CHARACTERIZATION OF THE FLUID

to the subregion averages; the very nature of the continuity requirement shows that it does not matter what reasonable method is used. In practice, the replacement is not actually performed, but the concept of it is useful in the interpretation of results.

We now assume that there is no difficulty in talking about the value of a fluid property "at a point," and that it is clear what is meant, for example, by differential elements of mass, energy, and momentum, and gradients of density.

The derivations to follow are based upon two additional assumptions. First, the molecules which are in a particular subregion at any given time remain forever in that same subregion; second, except for macroscopic slippage, every pair of contiguous subregions remains forever contiguous. Actually, these assumptions applied to a gas include a restatement of the neglect of viscosity and heat conduction.

We shall not dwell on these awkward matters, because it is possible to follow quite a different and much more satisfactory approach to the formulation of the macroscopic dynamics. (An introduction to the alternative is given in Chapter VIII.) We shall here proceed on a "semi-intuitive" basis, using a liberal interpretation of our basic assumptions as required.

Characterization of the Fluid

To completely specify the state of a fluid, it is necessary to give the values of certain "field variables" for every point in the fluid. Some of these are:

I. THE BASIC EQUATIONS

\vec{r}_0 \equiv Lagrangian coordinate. This is the permanent label which is attached to a point moving with the fluid. It may be chosen in any manner as long as it is different for each point. The symbol is as shown, because frequently the Lagrangian coordinate is chosen to be the position of the point at some reference time ($t = t_0$). Its Cartesian components are then x_0, y_0, z_0 . (In many of our discussions, the subscripts will be omitted when it is clear that the Lagrangian form is used.)

\vec{r} \equiv Eulerian coordinate. This is the position of a point relative to some external reference frame. The Eulerian coordinate is a function of \vec{r}_0 and of the time, t .

Each of the following field variables can be considered to depend upon the time and either the Lagrangian or the Eulerian coordinate:

ρ \equiv Mass density of the fluid

V \equiv Specific* volume ($V = 1/\rho$)

p \equiv Pressure

\vec{u} \equiv Velocity of the point $\left[\vec{u} = \frac{\partial \vec{r}(\vec{r}_0, t)}{\partial t} \right]$. The velocity could

also be called the specific momentum, just as $1/2 \vec{u} \cdot \vec{u}$ is the specific kinetic energy.

I \equiv Specific internal energy

T \equiv Temperature

S \equiv Specific entropy

E \equiv Specific total energy ($E = I + 1/2 \vec{u} \cdot \vec{u}$)

This notation is used throughout the manual except as otherwise explicitly stated. Additional terms are introduced and defined as they are needed.

*"Specific" quantities are measured per unit mass.

One-Dimensional Flow

It is necessary to establish clearly the difference between two types of "one-dimensional" motion of a fluid. In pseudo one-dimensional motion, all quantities characterizing the fluid are functions of one space coordinate only (as, for example, x in Cartesian coordinates or the angle θ in cylindrical coordinates). In true one-dimensional motion there is the additional feature that all velocity components vanish except the one along that coordinate direction.

Conservation of Mass

Consider a closed surface composed of points which move with the fluid; according to the assumptions of our model, the mass of fluid within that surface will never change. This fact can be exploited in the derivation of one of the basic fluid-dynamic equations.

As an example of the derivation, consider a true one-dimensional flow. The mass per unit transverse area contained between the Eulerian boundaries x_1 and x_2 is

$$m = \int_{x_1}^{x_2} \rho dx$$

Thus

$$\frac{dm}{dt} = \rho(x_2, t) \frac{dx_2}{dt} - \rho(x_1, t) \frac{dx_1}{dt} + \int_{x_1}^{x_2} \frac{\partial \rho}{\partial t} dx \equiv \int_{x_1}^{x_2} \left[\frac{\partial \rho u}{\partial x} + \frac{\partial \rho}{\partial t} \right] dx$$

This must vanish for any arbitrary interval, so that the integrand itself must vanish at every point:

$$\frac{\partial \rho}{\partial t} + \frac{\partial \rho u}{\partial x} = 0 \quad (1)$$

I. THE BASIC EQUATIONS

This is the one-dimensional mass conservation equation in Eulerian coordinates.

In three dimensions, consider the closed surface to be a cube at some instant of time. Then the mass within the cube is

$$m = \int_{x_1}^{x_2} \int_{y_1}^{y_2} \int_{z_1}^{z_2} \rho \, dx dy dz$$

and

$$\begin{aligned} \frac{dm}{dt} &= \int_{x_1}^{x_2} \int_{y_1}^{y_2} \int_{z_1}^{z_2} \frac{\partial \rho}{\partial t} \, dx dy dz + \int_{x_1}^{x_2} \int_{y_1}^{y_2} \left[\rho \frac{\partial z}{\partial t} \right]_{z_1}^{z_2} dx dy \\ &+ \int_{y_1}^{y_2} \int_{z_1}^{z_2} \left[\rho \frac{\partial x}{\partial t} \right]_{x_1}^{x_2} dy dz + \int_{z_1}^{z_2} \int_{x_1}^{x_2} \left[\rho \frac{\partial y}{\partial t} \right]_{y_1}^{y_2} dz dx \\ &\equiv \int_{x_1}^{x_2} \int_{y_1}^{y_2} \int_{z_1}^{z_2} \left[\frac{\partial \rho}{\partial t} + \frac{\partial}{\partial x} (\rho u_x) + \frac{\partial}{\partial y} (\rho u_y) + \frac{\partial}{\partial z} (\rho u_z) \right] dx dy dz \end{aligned}$$

Again, the integrand must vanish at every point, so that the equation may be written, in vector form,

$$\frac{\partial \rho}{\partial t} + \nabla \cdot (\rho \vec{u}) = 0 \quad (2)$$

The above procedure for forming the time derivative of a quantity is quite general. Thus, if $\lambda(\vec{r}, t)$ is any quantity measured per unit volume, then the total of that quantity throughout some volume moving with the fluid is

$$\Lambda = \int \lambda \, d\tau$$

CONSERVATION OF MOMENTUM

where $d\tau$ is a generalized volume element, and the range of integration covers the volume. Then one can derive, analogous to above

$$\frac{d\Lambda}{dt} = \int \left[\frac{\partial \lambda}{\partial t} + \nabla \cdot (\lambda \vec{u}) \right] d\tau \quad (3)$$

This formula can also be interpreted by rewriting it in the form

$$\frac{d\Lambda}{dt} = \frac{\partial}{\partial t} \int \lambda d\tau + \int \hat{n} \cdot \lambda \vec{u} da \quad (4)$$

where use has been made of the divergence theorem to transform the second term into an integral over the surface; \hat{n} is a unit outward normal to the surface and da is an element of its area.

Thus, the total rate of change of Λ can be considered to arise from two processes. The first term on the right of (4) signifies the change that would occur if the surface remained fixed — did not move with the fluid. In the second term, $\hat{n} \cdot \vec{u} da$ is the rate at which volume is swept up by the moving surface; multiplication by λ gives the rate at which the quantity is swept up. Thus, the second term "catches up" with what was lost from the first term, in which the surface was considered fixed.

Conservation of Momentum

The momentum per unit volume is $\rho \vec{u}$, so that the total momentum in any volume moving with the fluid is

$$\vec{M} = \int \rho \vec{u} d\tau$$

I. THE BASIC EQUATIONS

Thus*

$$\frac{d\vec{M}}{dt} = \int \left[\frac{\partial \rho \vec{u}}{\partial t} + \nabla \cdot (\rho \vec{u} \vec{u}) \right] d\tau$$

At any point, the force acting on a surface element, da , is $(-\hat{n}p \ da)$, so that also

$$\frac{d\vec{M}}{dt} = - \int \hat{n}p \ da$$

Transforming this to a volume integral and comparing with the previous result, we find

$$\int \left[\frac{\partial \rho \vec{u}}{\partial t} + \nabla \cdot (\rho \vec{u} \vec{u}) \right] d\tau = - \int \nabla p \ d\tau$$

Again, the integrand must vanish, and the momentum equation is

$$\frac{\partial \rho \vec{u}}{\partial t} + \nabla \cdot (\rho \vec{u} \vec{u}) = - \nabla p \quad (5)$$

Conservation of Energy

The energy per unit volume is ρE and the rate of doing work on an element of its area is $-\hat{n} \cdot p \vec{u} \ da$. Thus, with no heat conduction in the fluid

$$\frac{d}{dt} \int \rho E d\tau = - \int \hat{n} \cdot p \vec{u} \ da$$

*The quantity $\nabla \cdot (\rho \vec{u} \vec{u})$ is obtained by considering individually the scalar components of either \vec{u} and combining results. Thus, $\nabla \cdot (\rho \vec{u} \vec{u}) = (\rho \vec{u} \cdot \nabla) \vec{u} + \vec{u} (\nabla \cdot \rho \vec{u})$ or $\nabla \cdot (\rho \vec{u} \vec{u}) = (\vec{u} \cdot \nabla) \rho \vec{u} + \rho \vec{u} (\nabla \cdot \vec{u})$.

LAGRANGIAN FORM OF THE EQUATIONS

The same sort of manipulation as before leads to

$$\frac{\partial \rho E}{\partial t} + \nabla \cdot (\rho E \vec{u}) = - \nabla \cdot (p \vec{u}) \quad (6)$$

Lagrangian Form of the Equations

The three basic equations, (2), (5), and (6), can be written as the following equivalent set:

$$\left(\frac{\partial}{\partial t} + \vec{u} \cdot \nabla \right) \rho = - \rho \nabla \cdot \vec{u} \quad (7)$$

$$\rho \left(\frac{\partial}{\partial t} + \vec{u} \cdot \nabla \right) \vec{u} = - \nabla p \quad (8)$$

$$\rho \left(\frac{\partial}{\partial t} + \vec{u} \cdot \nabla \right) E = - \nabla \cdot (p \vec{u}) \quad (9)$$

In all three equations there appears the operator $\frac{\partial}{\partial t} + \vec{u} \cdot \nabla$. This is called the time differential operator along the particle path. To see the reason for this, suppose that one wishes to find the rate of change of a quantity, λ , per unit time along some space-time path characterized by $d\vec{r}$ and dt . Then

$$\frac{d\lambda}{dt} = \frac{\partial \lambda}{\partial t} + \frac{d\vec{r}}{dt} \cdot \nabla \lambda$$

Along that special path for which $\frac{d\vec{r}}{dt} = \left(\frac{\partial \vec{r}}{\partial t} \right)_{\vec{r}_0} = \vec{u}$, then

$$\frac{d\lambda}{dt} \rightarrow \frac{\partial \lambda}{\partial t} + \vec{u} \cdot \nabla \lambda$$

This special path is just that taken by a point moving with the fluid.

Thus

I. THE BASIC EQUATIONS

$$\frac{D\lambda}{Dt} \equiv \left(\frac{\partial \lambda}{\partial t} \right)_{\vec{r}_0} = \left(\frac{\partial \lambda}{\partial t} \right)_{\vec{r}} + \vec{u} \cdot \nabla \lambda \quad (10)$$

where the subscripts are used to show explicitly what is being held constant in each derivative. The notation involving the capital D will occasionally be useful in this manual in designating an infinitesimal change along the motion of the fluid.

Equations (7), (8), and (9) in Eulerian form may be transformed to the Lagrangian form. The process is most conveniently illustrated in one dimension. As an example, consider the mass equation in which subscripts show explicitly what is being held constant:

$$\left(\frac{\partial \rho}{\partial t} \right)_x + u \left(\frac{\partial \rho}{\partial x} \right)_t + \rho \left(\frac{\partial u}{\partial x} \right)_t = 0 \quad (11)$$

We have seen from (10) that this can be written

$$\left(\frac{\partial \rho}{\partial t} \right)_{x_0} + \rho \left(\frac{\partial u}{\partial x} \right)_t = 0 \quad (12)$$

To complete the transformation, we note that

$$\rho_0 dx_0 \equiv \rho dx \quad (13)$$

where ρ_0 is the density at the time at which $x = x_0$. This expresses the fact that the mass between any two adjacent points is the same, whether observed from the Eulerian or Lagrangian viewpoint. Thus, with ρ and u being functions of x_0 and t , and ρ_0 being a function of x_0 , (12) becomes

LAGRANGIAN FORM OF THE EQUATIONS

$$\left(\frac{\partial \rho}{\partial t}\right)_{x_0} + \frac{\rho^2}{\rho_0} \left(\frac{\partial u}{\partial x}\right)_t = 0 \quad (14)$$

This is the Lagrangian form of the mass equation.

The transformation can also be performed in a somewhat more elegant fashion. First, consider the return from (14) to (11). Let the Eulerian and Lagrangian coordinate systems coincide at time $t = 0$. We then make the coordinate transformation in (14):

$$\left. \begin{aligned} x &= x_0 + \int_0^t u(x_0, t) dt \\ z &= t \end{aligned} \right\} \quad (15)$$

where the integration is performed with fixed x_0 . Thus

$$\left(\frac{\partial}{\partial x}\right)_t = \left(\frac{\partial x}{\partial x}\right)_t \left(\frac{\partial}{\partial x}\right)_z + \left(\frac{\partial z}{\partial x}\right)_t \left(\frac{\partial}{\partial z}\right)_x \quad (16)$$

Now

$$\left(\frac{\partial x}{\partial x}\right)_t = 1 + \int_0^t \left(\frac{\partial u}{\partial x}\right)_t dt = 1 + \int_0^t \left[-\frac{\rho_0}{\rho^2} \left(\frac{\partial \rho}{\partial t}\right)_{x_0}\right] dt$$

where use has been made of (14). Then

$$\left(\frac{\partial x}{\partial x}\right)_t = 1 + \int_0^t \left(\frac{\partial(\rho_0/\rho)}{\partial t}\right)_{x_0} dt = 1 + \frac{\rho_0}{\rho} \Big|_0^t = \frac{\rho_0}{\rho}$$

This result is the same as (13). Thus (16) becomes

$$\left(\frac{\partial}{\partial x}\right)_t = \frac{\rho_0}{\rho} \left(\frac{\partial}{\partial x}\right)_z \quad (17)$$

Also,

I. THE BASIC EQUATIONS

$$\left(\frac{\partial}{\partial t}\right)_{x_0} = \left(\frac{\partial x}{\partial t}\right)_{x_0} \left(\frac{\partial}{\partial x}\right)_z + \left(\frac{\partial x}{\partial t}\right)_{x_0} \left(\frac{\partial}{\partial z}\right)_x$$

or

$$\left(\frac{\partial}{\partial t}\right)_{x_0} = u \left(\frac{\partial}{\partial x}\right)_z + \left(\frac{\partial}{\partial z}\right)_x \quad (18)$$

If we put (17) and (18) into (14) and replace $z \rightarrow t$, then we obtain (11).

The reverse transformation by this method is not as simple, but is worth presenting since it shows more about the choice of $\rho_0(x_0)$ and points out the procedure required in the more general three-dimensional equations. We start from the Eulerian equation with z still replacing t :

$$\left(\frac{\partial \rho}{\partial z}\right)_x + u \left(\frac{\partial \rho}{\partial x}\right)_z + \rho \left(\frac{\partial u}{\partial x}\right)_z = 0 \quad (19)$$

Define

$$\Theta(x_0, t) \equiv \left(\frac{\partial x}{\partial x_0}\right)_t \quad (20)$$

Then, from (15)

$$\Theta = 1 + \int_0^t \left(\frac{\partial u}{\partial x_0}\right)_t dt = 1 + \int_0^t \left(\frac{\partial x}{\partial x_0}\right)_t \left(\frac{\partial u}{\partial x}\right)_z dt$$

where we had to use (16), because (17) is as yet not known for this reverse transformation. Thus, using (19), we obtain

$$\Theta = 1 + \int_0^t \Theta \left\{ -\frac{1}{\rho} \left[\left(\frac{\partial \rho}{\partial z}\right)_x + u \left(\frac{\partial \rho}{\partial x}\right)_z \right] \right\} dt$$

LAGRANGIAN FORM OF THE EQUATIONS

which becomes, with (18),

$$\Theta = 1 - \int_0^t \frac{\Theta}{\rho} \left(\frac{\partial \rho}{\partial t} \right)_{x_0} dt \quad (21)$$

The integration is to be performed with x_0 constant, so that

$$\left(\frac{\partial \Theta}{\partial t} \right)_{x_0} = - \frac{\Theta}{\rho} \left(\frac{\partial \rho}{\partial t} \right)_{x_0}$$

This may be integrated after division by Θ , leading to

$$\Theta \rho = K(x_0) \quad (22)$$

where $K(x_0)$ is an "arbitrary" function of its argument, which may be determined, however, by substitution back into the integral equation (21):

$$\begin{aligned} \Theta &= 1 - \int_0^t \frac{K(x_0)}{\rho^2} \left(\frac{\partial \rho}{\partial t} \right)_{x_0} dt = 1 + K(x_0) \int_0^t \left(\frac{\partial(1/\rho)}{\partial t} \right)_{x_0} dt \\ &= 1 + \frac{K(x_0)}{\rho} - \frac{K(x_0)}{\rho_0} \end{aligned}$$

To agree with (22), we see that $K(x_0) \equiv \rho_0$ so that combining with (20) we finally obtain

$$\left(\frac{\partial x}{\partial x_0} \right)_t = \frac{\rho_0}{\rho}$$

and the transformation can proceed in a straightforward manner.

I. THE BASIC EQUATIONS

Usually the analogous three-dimensional transformation to Lagrangian coordinates will involve such a complicated Jacobian that no advantage is gained. In one dimension, however, we shall have several occasions for using the Lagrangian forms, and it is useful to summarize them here.

$$\left. \begin{aligned} \frac{\partial \rho}{\partial t} + \frac{\rho^2}{\rho_0} \frac{\partial u}{\partial x_0} &= 0 \\ \rho_0 \frac{\partial u}{\partial t} + \frac{\partial p}{\partial x_0} &= 0 \\ \rho_0 \frac{\partial E}{\partial t} + \frac{\partial p u}{\partial x_0} &= 0 \end{aligned} \right\} \quad (23)$$

Time Derivatives of a Volume Integral

Let $\lambda(\vec{r}, t)$ be some quantity density; then there are two main types of volume integrals of λ which will be of interest:

$$\Lambda(\text{Eulerian}) \equiv \int_V \lambda(\vec{r}, t) d\tau$$

and

$$\Lambda(\text{Lagrangian}) \equiv \int_{V_0} \lambda[\vec{r}(\vec{r}_0, t), t] d\tau_0$$

The first one, which we have discussed before, is an integral over a volume V moving with the fluid. The second, in which λ is re-expressed as a function of the Lagrangian coordinates, is an integral of λ over some fixed initial volume.

We have seen before (3) that

TIME DERIVATIVES OF A VOLUME INTEGRAL

$$\frac{d\Lambda(\text{Eulerian})}{dt} = \int_V \left[\frac{\partial \lambda}{\partial t} + \nabla \cdot (\lambda \vec{u}) \right] d\tau$$

The time derivative of the Lagrangian integral is simpler to perform; since each element of volume in the sum is constant, the derivative is

$$\frac{d\Lambda(\text{Lagrangian})}{dt} = \int_{V_0} \left[\frac{\partial \lambda(\vec{r}_0, t)}{\partial t} \right]_{\vec{r}_0} d\tau_0$$

Now, the time derivative of the Eulerian integral can be derived in another illustrative way. We first transform it to a Lagrangian integral:

$$\frac{d\Lambda(\text{Eulerian})}{dt} = \int_{V_0} \lambda \left[\vec{r}(\vec{r}_0, t), t \right] \frac{\rho_0}{\rho} d\tau_0$$

where ρ_0/ρ is the transformation Jacobian (whose form follows from the fact that $\rho d\tau \equiv \rho_0 d\tau_0$). Thus

$$\frac{d\Lambda(\text{Eulerian})}{dt} = \int_{V_0} \left\{ \left(\frac{\partial \lambda}{\partial t} \right)_{\vec{r}_0} \frac{\rho_0}{\rho} + \lambda \left[\frac{\partial(\rho_0/\rho)}{\partial t} \right]_{\vec{r}_0} \right\} d\tau_0$$

where all quantities in the integrand depend spatially on the Lagrangian coordinates. Now the mass equation (14) can be put into the mixed form

$$\left[\frac{\partial(\rho_0/\rho)}{\partial t} \right]_{\vec{r}_0} = \frac{\rho_0}{\rho} \nabla \cdot \vec{u}$$

I. THE BASIC EQUATIONS

where the divergence is Eulerian. Thus

$$\begin{aligned} \frac{d\Lambda(\text{Eulerian})}{dt} &= \int_{V_0} \left\{ \left[\frac{\partial \lambda}{\partial t} \right]_{\vec{r}_0} + \lambda \nabla \cdot \vec{u} \right\} \left(\frac{\rho_0}{\rho} \right) d\tau_0 \\ &= \int_V \left[\frac{D\lambda}{Dt} + \lambda \nabla \cdot \vec{u} \right] d\tau \end{aligned}$$

where use has been made of (10). The derivative formula given before follows immediately. This type of transformation appears at first cumbersome, but is sometimes extremely useful. Note the special case

$$\frac{d}{dt} \int_V \rho \lambda d\tau \equiv \int_V \rho \frac{D\lambda}{Dt} d\tau$$

which follows from a similar derivation.

One-Dimensional Conservative Form

In one dimension, the Eulerian equations may be written

$$\left. \begin{aligned} \frac{\partial \rho}{\partial t} + \frac{\partial \rho u}{\partial x} &= 0 \\ \frac{\partial \rho u}{\partial t} + \frac{\partial}{\partial x} (\rho u^2 + p) &= 0 \\ \frac{\partial \rho E}{\partial t} + \frac{\partial}{\partial x} (\rho u E + pu) &= 0 \end{aligned} \right\} \quad (24)$$

and the Lagrangian equations may be written

ONE-DIMENSIONAL CONSERVATIVE FORM

$$\left. \begin{aligned} \frac{\partial(\rho_0/\rho)}{\partial t} - \frac{\partial u}{\partial x_0} &= 0 \\ \frac{\partial \rho_0 u}{\partial t} + \frac{\partial p}{\partial x_0} &= 0 \\ \frac{\partial \rho_0 E}{\partial t} + \frac{\partial pu}{\partial x_0} &= 0 \end{aligned} \right\} \quad (25)$$

Equations (24) and (25) are called the conservative forms. Integration of any one of them over a fixed space interval (Eulerian or Lagrangian, as appropriate) reveals the reason. Consider the Eulerian momentum equation as an example. With x_1 and x_2 being fixed Eulerian positions, we obtain

$$\frac{\partial}{\partial t} \int \rho u \, dx = (\rho u^2 + p)_{x=x_1} - (\rho u^2 + p)_{x=x_2}$$

Thus, there is no internal contribution to the timewise variation of momentum in the interval; its momentum changes only if there are boundary fluxes. In this case, the boundary flux is composed of two terms. The transport term, ρu^2 , measures the rate at which momentum is carried by the moving fluid; the force term, p , measures the acceleration due to external pressures.

The conservative equations are all of the form

$$\frac{\partial A}{\partial t} + \frac{\partial B}{\partial x} = 0$$

I. THE BASIC EQUATIONS

If $F(x,t)$ is any arbitrary function of its arguments, then

$$B = \frac{\partial F}{\partial t}$$

$$A = - \frac{\partial F}{\partial x}$$

is the most general solution of the equation. Now

$$dF = \frac{\partial F}{\partial t} dt + \frac{\partial F}{\partial x} dx \equiv B dt - A dx$$

Since dF is a perfect differential, its integral around any arbitrary closed path in the x - t plane is zero. Thus

$$\oint (B dt - A dx) \equiv 0$$

This equation is equivalent to the original one. Thus, the one-dimensional Eulerian equations in integral form are

$$\left. \begin{aligned} \oint (\rho u dt - \rho dx) &= 0 \\ \oint [(\rho u^2 + p)dt - \rho u dx] &= 0 \\ \oint [(\rho u E + pu)dt - \rho E dx] &= 0 \end{aligned} \right\} \quad (26)$$

and the Lagrangian equations are

$$\left. \begin{aligned} \oint (u dt + \frac{\rho_0}{\rho} dx_0) &= 0 \\ \oint (p dt - \rho_0 u dx_0) &= 0 \\ \oint (pu dt - \rho_0 E dx_0) &= 0 \end{aligned} \right\} \quad (27)$$

OTHER COORDINATE SYSTEMS

These equations in integral form will be useful in later developments.

Other Coordinate Systems

The equations for a particular problem can often be simplified in form if a coordinate transformation is made. Various compilations have been given of the equations in the more common coordinate systems (see, for instance, Pai^{*}).

A convenient starting point for transforming coordinates is the set of equations in general vector, Eulerian form. Consider, for example, the momentum equation:

$$\rho \frac{\partial \vec{u}}{\partial t} + \rho(\vec{u} \cdot \nabla) \vec{u} = - \nabla p$$

If $\hat{\eta}$ is one of the three unit vectors of some curvilinear coordinate system, then the dot product of $\hat{\eta}$ with the equation will give the appropriate component equation in the desired system:

$$\rho \frac{\partial u_{\eta}}{\partial t} + \rho \hat{\eta} \cdot [(\vec{u} \cdot \nabla) \vec{u}] = - \frac{\partial p}{\partial x_{\eta}}$$

where u_{η} is the component of velocity in the direction of $\hat{\eta}$, and dx_{η} is the change in distance along a path in the direction of $\hat{\eta}$. Now

$$\hat{\eta} \cdot [(\vec{u} \cdot \nabla) \vec{u}] = (\vec{u} \cdot \nabla)(\hat{\eta} \cdot \vec{u}) - \vec{u} \cdot [(\vec{u} \cdot \nabla) \hat{\eta}]$$

The second term on the right vanishes only if $\hat{\eta}$ is a constant everywhere. While $\hat{\eta}$ is always constant in magnitude, it is not generally constant in

* S. Pai, "Viscous Flow Theory, I - Laminar Flow," D. Van Nostrand Company, Inc., Princeton, 1956.

I. THE BASIC EQUATIONS

direction, and the second term does not vanish.

As an example, consider the transformation to cylindrical coordinates. The three unit vectors in the radial, angular, and axial directions are, respectively, \hat{r} , $\hat{\theta}$, \hat{z} . We are thus concerned with finding $\nabla\hat{r}$, $\nabla\hat{\theta}$, and $\nabla\hat{z}$. In general in cylindrical coordinates,

$$\nabla_{\hat{\eta}} = \hat{r} \frac{\partial \hat{\eta}}{\partial r} + \hat{\theta} \frac{1}{r} \frac{\partial \hat{\eta}}{\partial \theta} + \hat{z} \frac{\partial \hat{\eta}}{\partial z}$$

where the order of vectors is preserved throughout. Thus we must find, for example, $\partial\hat{r}/\partial\theta$. A graphical approach will be illustrative. The

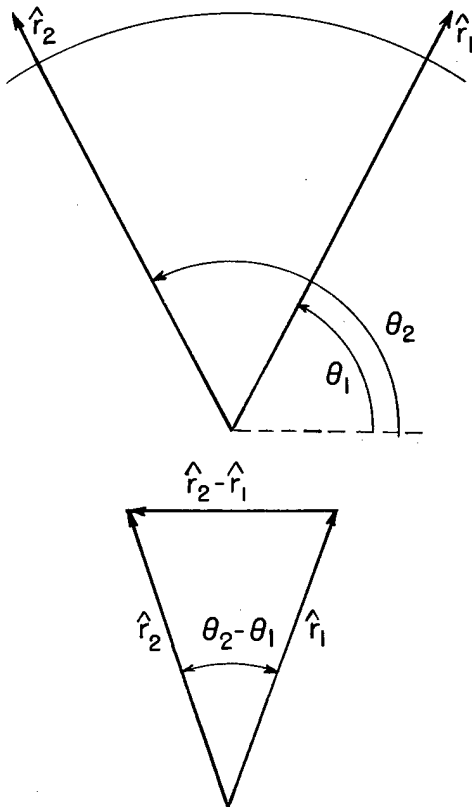

vector $\hat{r}_2 - \hat{r}_1$ points approximately in the direction of $\hat{\theta}$ (and will do so exactly as $\theta_2 - \theta_1 \rightarrow 0$). Also, $\hat{r}_2 - \hat{r}_1$ has limiting magnitude $(\theta_2 - \theta_1)$ times the magnitude of \hat{r}_2 or \hat{r}_1 . Thus $(\hat{r}_2 - \hat{r}_1)/(\theta_2 - \theta_1) \approx \hat{\theta}$ and $\partial\hat{r}/\partial\theta = \hat{\theta}$. In similar fashion, the other appropriate derivatives may be found, and $\nabla\hat{r} = (1/r) \hat{\theta}\hat{\theta}$, $\nabla\hat{\theta} = -(1/r) \hat{\theta}\hat{r}$, $\nabla\hat{z} = 0$. Thus,

$$\vec{u} \cdot [(\vec{u} \cdot \nabla)\hat{r}] = \frac{u_{\theta}^2}{r}$$

$$\vec{u} \cdot [(\vec{u} \cdot \nabla)\hat{\theta}] = -\frac{u_r u_{\theta}}{r}$$

and the component equations of motion are:

$$\rho \frac{\partial u_r}{\partial t} + \rho(\vec{u} \cdot \nabla)u_r - \rho \frac{u_\theta^2}{r} = - \frac{\partial p}{\partial r} \quad (28)$$

$$\rho \frac{\partial u_\theta}{\partial t} + \rho(\vec{u} \cdot \nabla)u_\theta + \rho \frac{u_r u_\theta}{r} = - \frac{1}{r} \frac{\partial p}{\partial \theta} \quad (29)$$

$$\rho \frac{\partial u_z}{\partial t} + \rho(\vec{u} \cdot \nabla)u_z = - \frac{\partial p}{\partial z} \quad (30)$$

Notice, in passing, that one aspect of these equations can be given what at first seems a puzzling interpretation. If $u_\theta \equiv 0$, then (28) becomes

$$\rho \frac{Du_r}{Dt} = - \frac{\partial p}{\partial r}$$

Thus

$$\int_{r_1}^{r_2} \rho \frac{Du_r}{Dt} d\tau = - \int_{r_1}^{r_2} \frac{\partial p}{\partial r} d\tau$$

where $d\tau$ is the element of volume of a cylindrical shell of length L .

Thus

$$\int_{r_{1,0}}^{r_{2,0}} \rho_0 \frac{\partial u_r}{\partial t} d\tau_0 = - 2\pi L \int_{r_1}^{r_2} r \frac{\partial p}{\partial r} dr$$

Define the mean radial speed, \bar{u}_r , of the shell contained between r_1 and r_2 by

$$\int_{r_{1,0}}^{r_{2,0}} \rho_0 u_r d\tau_0 \equiv m \bar{u}_r$$

where m is the shell mass. Then

I. THE BASIC EQUATIONS

$$\begin{aligned} m \frac{d\bar{u}_r}{dt} &= - 2\pi L \int_{r_1}^{r_2} \left[\frac{\partial p}{\partial r} - p \right] dr \\ &= (pA)_{\text{inside}} - (pA)_{\text{outside}} + 2\pi L \int_{r_1}^{r_2} p dr \end{aligned}$$

where A is the surface area of the inside or outside of the shell. Thus the acceleration of the shell is produced by more than the difference between the external forces; even if these vanish, the internal pressure within the cell causes its radial acceleration.

Equation of State

The equations so far discussed apply quite generally to all simple fluids. Reference to any set of them — (24), for example — shows that the number of equations is always one less than the number of dependent variables, and thus insufficient for a complete description of any process. The required additional relation is one characterizing the fluid itself. It is called the equation of state; we often write it in the form

$$p = f(\rho, T) \tag{31}$$

and accept its existence as being an experimental fact.

It has been observed that many gases closely follow the "ideal gas" equation of state:

$$p = NR\rho T \tag{32}$$

THE EQUATIONS FOR A FLUID WITH NONLOCAL FORCES

where R is the universal gas constant and N is the number of moles per unit mass (or the reciprocal of the molecular weight). Much of our discussion will relate to ideal gases.

The Equations for a Fluid with Nonlocal Forces

If each element of fluid is subject to forces exerted by other than its immediate neighboring elements, then additional terms are required in the equations. (Such forces would be present, for example, in a gas with net electric charge, or one acted upon by an external gravitational field.) The mass equation remains unchanged by such forces. If the force per unit mass (the acceleration) is \vec{g} , then the momentum equation becomes, in Eulerian coordinates,

$$\frac{\partial \vec{u}}{\partial t} + (\vec{u} \cdot \nabla) \vec{u} = - \frac{1}{\rho} \nabla p + \vec{g} \quad (33)$$

The rate at which work is done by the external force on the element is $\vec{u} \cdot \vec{g}$. Thus the energy equation becomes

$$\frac{\partial E}{\partial t} + (\vec{u} \cdot \nabla) E = - \frac{1}{\rho} \nabla \cdot (p\vec{u}) + \vec{u} \cdot \vec{g} \quad (34)$$

Suppose now that

$$\vec{g} \equiv \vec{g}_1(\vec{r}) + \vec{g}_2(\vec{r}, t)$$

where \vec{g}_1 is the acceleration produced by forces from outside the fluid, and \vec{g}_2 is that produced by distant action on elements within the fluid. Suppose further that \vec{g}_1 and \vec{g}_2 both can be expressed as gradients of

I. THE BASIC EQUATIONS

functions

$$\vec{g}_1 \equiv -\nabla \phi_1(\vec{r})$$

$$\vec{g}_2 \equiv -\nabla \phi_2(\vec{r}, t)$$

and finally, that

$$\phi_2(\vec{r}, t) \equiv \int \rho(\vec{r}', t) \phi(\vec{r} - \vec{r}') d\tau'$$

where the integration is over the entire volume of the fluid, and $\phi(\vec{r} - \vec{r}') \equiv \phi(\vec{r}' - \vec{r})$. These assumptions are not very restrictive; they are valid for many physical situations of interest.

The momentum equation (33) can then be written

$$\frac{\partial \rho \vec{u}}{\partial t} + \nabla \cdot (\rho \vec{u} \vec{u} + p) = \rho \vec{g}_1 - \int \rho(\vec{r}, t) \rho(\vec{r}', t) \nabla_{\vec{r}} \phi(\vec{r} - \vec{r}') d\tau'$$

so that, to demonstrate momentum conservation, we integrate over volume

$$\frac{d}{dt} \int \rho \vec{u} d\tau = \int \rho \vec{g}_1 d\tau$$

where vanishing of the integral of the second term on the right follows from

$$\begin{aligned} \text{Second term} &\equiv \iint \rho(\vec{r}, t) \rho(\vec{r}', t) \nabla_{\vec{r}} \phi(\vec{r} - \vec{r}') d\tau d\tau' \\ &\equiv - \iint \rho(\vec{r}, t) \rho(\vec{r}', t) \nabla_{\vec{r}'} \phi(\vec{r}' - \vec{r}) d\tau d\tau' \\ &\equiv - (\text{Second term}) \end{aligned}$$

Thus, the total momentum of the fluid is affected only by the external forces.

THE EQUATIONS FOR A FLUID WITH NONLOCAL FORCES

The energy equation (34) can be treated in similar fashion. We re-write it in identically equivalent form

$$\frac{\partial}{\partial t} \left[\rho E + \frac{1}{2} \rho (\varphi_1 + \varphi_2) \right] + \nabla \cdot \left[\rho \vec{u} E + \frac{1}{2} \rho \vec{u} (\varphi_1 + \varphi_2) + p \vec{u} \right] =$$

$$\frac{1}{2} \rho \left[\frac{\partial (\varphi_1 + \varphi_2)}{\partial t} - \vec{u} \cdot \nabla (\varphi_1 + \varphi_2) \right]$$

wherein use has been made of the mass conservation equation (2). Again we integrate this over the whole fluid and arrive at the result

$$\frac{d}{dt} \int \left[\rho E + \frac{1}{2} \rho (\varphi_1 + \varphi_2) \right] d\tau = 0$$

Vanishing of the integral of the right side of the equation is demonstrated as follows:

$$\text{Integral} \equiv \frac{1}{2} \int \rho \left[\frac{\partial (\varphi_1 + \varphi_2)}{\partial t} - \vec{u} \cdot \nabla (\varphi_1 + \varphi_2) \right] d\tau$$

$$\equiv \frac{1}{2} \int \left[\rho \frac{\partial (\varphi_1 + \varphi_2)}{\partial t} + (\varphi_1 + \varphi_2) \nabla \cdot \rho \vec{u} \right] d\tau$$

where we have dropped a term which integrates to zero. Using the mass equation we get

$$\text{Integral} \equiv \frac{1}{2} \int \left[\rho \frac{\partial (\varphi_1 + \varphi_2)}{\partial t} - (\varphi_1 + \varphi_2) \frac{\partial \rho}{\partial t} \right] d\tau$$

$$\equiv \frac{1}{2} \varphi_1 \frac{d}{dt} \int \rho d\tau + \frac{1}{2} \int \left(\rho \frac{\partial \varphi_2}{\partial t} - \varphi_2 \frac{\partial \rho}{\partial t} \right) d\tau$$

I. THE BASIC EQUATIONS

The first term vanishes since total mass is conserved. Consider one term in the second part:

$$\begin{aligned}\int \rho \frac{\partial \varphi_2}{\partial t} d\tau &\equiv \iint \rho(\vec{r}, t) \Phi(\vec{r} - \vec{r}') \frac{\partial}{\partial t} \rho(\vec{r}', t) d\tau d\tau' \\ &\equiv \iint \rho(\vec{r}', t) \Phi(\vec{r} - \vec{r}') \frac{\partial}{\partial t} \rho(\vec{r}, t) d\tau d\tau' \\ &\equiv \int \varphi_2 \frac{\partial \rho}{\partial t} d\tau\end{aligned}$$

so that the second integral is self-cancelling. Thus it is shown that the total "potential" energy of the system is

$$\frac{1}{2} \int \rho(\varphi_1 + \varphi_2) d\tau$$

and this plus the kinetic and internal energy of the system are altogether conserved.

CHAPTER II

DISCUSSION OF THE EQUATIONS

The Polytropic Equation of State

The specific entropy change, DS , along the motion of a point is defined* by the equation

$$TDS = DI - \frac{P}{\rho} D\rho \quad (1)$$

The second law of thermodynamics states that DS is a perfect differential; that is, that the entropy at any point in a fluid is a function of the instantaneous state at that point. For an ideal gas, with equation of state (I-32),

$$DS = \frac{1}{T} DI - \frac{NR}{\rho} D\rho$$

Now, since DS is a perfect differential, here considered a function of the independent variables ρ and I , we have

$$DS = \frac{\partial S}{\partial I} DI + \frac{\partial S}{\partial \rho} D\rho$$

* See, for example, P. S. Epstein, "Textbook of Thermodynamics," John Wiley and Sons, Inc., New York 1937.

II. DISCUSSION OF THE EQUATIONS

Comparing these two equations, we see that the condition of exactness applied to an ideal gas is

$$\frac{\partial S}{\partial I} = \frac{1}{T}, \quad \frac{\partial S}{\partial \rho} = -\frac{NR}{\rho}$$

from which

$$\frac{\partial(1/T)}{\partial \rho} = \frac{\partial}{\partial I} \left(-\frac{NR}{\rho} \right) = 0$$

so that T is a function of I alone. In an ideal gas, the specific internal energy is a function of temperature only. For many gases, it is sufficient to keep only a few terms in the Maclaurin expansion of I as a function of T :

$$I = a + bT + cT^2 + \dots$$

The internal energy can be chosen to vanish at $T = 0$. (T is thus the absolute temperature.) Those special gases for which only $b \neq 0$ are called "polytropic." Mathematically, they are relatively simple to handle and, under standard conditions, they often represent real gases quite closely.

For such a polytropic gas it is customary to define the dimensionless constant:

$$\gamma \equiv 1 + \frac{NR}{b}$$

in terms of which the polytropic equation of state can be written

$$p = (\gamma - 1)\rho I \tag{2}$$

CHANGES OF STATE IN A SIMPLE GAS

The significance of the constant, b , can be seen by a consideration of the process of adiabatic (reversible) heating of the gas. In such a process the heat change along the motion of a point is $DQ = TDS$, so that, from (1)

$$DQ = bDT - \frac{p}{2} D\rho \equiv bDT + pDV$$

Thus, if the volume is kept constant, then

$$\left(\frac{DQ}{DT}\right)_{V=\text{constant}} = b$$

so that b is the specific heat at constant volume. If, on the other hand, the temperature is changed at constant pressure, then, since $DV = (NR/p)DT$ [obtained from the ideal-gas equation of state, (I-32)], we obtain

$$\left(\frac{DQ}{DT}\right)_{p=\text{constant}} = b + NR$$

which is the specific heat at constant pressure. Thus γ is the ratio of these two specific heats.

Changes of State in a Simple Gas

As long as the field variables are continuous, the differential equations of Chapter I are meaningful; we examine some of their properties starting from the Eulerian form

$$\frac{D\rho}{Dt} = -\rho\nabla\cdot\vec{u}$$

II. DISCUSSION OF THE EQUATIONS

$$\rho \frac{D\vec{u}}{Dt} = - \nabla p$$

$$\rho \frac{DE}{Dt} = - \nabla \cdot p\vec{u}$$

For E, put $I + \frac{1}{2} \vec{u} \cdot \vec{u}$, and the third equation becomes

$$\rho \frac{DI}{Dt} + \rho \vec{u} \cdot \frac{D\vec{u}}{Dt} = - p \nabla \cdot \vec{u} - \vec{u} \cdot \nabla p$$

Eliminate $D\vec{u}/Dt$ by means of the momentum equation and $\nabla \cdot \vec{u}$ by means of the mass equation, and the result is

$$DI - \frac{p}{\rho} D\rho = 0 \quad (3)$$

Comparison with (1) shows that the specific entropy of each point remains constant as it moves with the fluid. The value may differ from point to point; if it does not, then the fluid is called "isentropic," and the above result shows that it remains isentropic.

One of the field variables can be removed from (3) by use of the equation of state, and the result is an equation which always can be integrated, yielding the "adiabatic equation of state." If, for example, I is eliminated by means of the polytropic equation (2), the integrated result is

$$p = A(\vec{r}_0) \rho^\gamma \quad (4)$$

where $A(\vec{r}_0)$ is an arbitrary function of the Lagrangian coordinate. This is the adiabatic equation of state for a polytropic gas.

The quantity $A(\vec{r}_0)$ is related to the entropy; the relation can be

CHANGES OF STATE IN A SIMPLE GAS

seen as follows. Suppose that by some process the values of p and ρ are changed at some point in such a way that the entropy is changed. Eliminate T and I as they occur in (1), (2), and (I-32) to obtain

$$\frac{\gamma - 1}{NR} DS = \frac{Dp}{p} - \frac{\gamma D\rho}{\rho} = D \left(\ln \frac{p}{\rho^\gamma} \right)$$

From (4),

$$DS = \frac{NR}{\gamma - 1} D \left[\ln A(\vec{r}_0) \right]$$

Thus,

$$S = \frac{NR}{\gamma - 1} \ln A(\vec{r}_0) + \text{constant} \equiv S_0 + \frac{NR}{\gamma - 1} \ln \left(\frac{p}{\rho^\gamma} \right) \quad (5)$$

Note that as $T \rightarrow 0$ for constant density, $p \rightarrow 0$ and $S \rightarrow -\infty$. Thus, no gas can behave as polytropic for very low temperatures.

For any simple fluid, the entropy of any element remains constant as long as the equations of motion are valid. It will be shown later, however, that certain initial-value, boundary-value problems do not possess solutions which are everywhere continuous, even if the initial and boundary conditions are continuous. Moving surfaces of discontinuity can arise, and at them the equations become meaningless. A special treatment is required, and one can be found which gives a useful meaning to these discontinuities, but a consequence of the treatment is that there is a change in entropy as a discontinuity passes over an element of the fluid.

II. DISCUSSION OF THE EQUATIONS

As soon as the real effects of viscosity and heat conduction are added to the equations, one no longer can derive the result $DS = 0$. Heat sources due to chemical or nuclear reactions also result in entropy production. These properties of nonsimple gases will be exhibited in Chapters VIII and IX.

Angular Velocity and Circulation

Relative to some axis defined by the unit vector \hat{q} , the angular velocity of a fluid element is

$$\omega_q = \frac{\hat{q} \cdot \vec{r} \times \vec{u}}{r^2}$$

where \vec{r} is a vector from an origin on the axis at the nearest point to the element.

To find the average angular velocity about \hat{q} in the neighborhood of a point on \hat{q} , we proceed as follows. First, find the average on a circle centered at the point and perpendicular to \hat{q} . This average is given by

$$2\pi R \bar{\omega}_q = \oint \frac{\hat{q} \cdot \vec{r} \times \vec{u}}{r^2} dr = \oint \left(\frac{\hat{q} \times \vec{r}}{r} dr \right) \cdot \frac{\vec{u}}{r} = \oint \frac{d\vec{r} \cdot \vec{u}}{r} = \frac{1}{R} \int \hat{q} \times \nabla \cdot \vec{u} da$$

where the line integral has been transformed to a surface integral over the plane surface bounded by the circle whose radius is R . Thus, the value is

$$\bar{\omega}_q = \frac{1}{2\pi R^2} \hat{q} \cdot \int \nabla \times \vec{u} da$$

If the circle is small enough that $\nabla \times \vec{u}$ varies little on it, then

ANGULAR VELOCITY AND CIRCULATION

$\int \nabla \times \vec{u} \, da \rightarrow \pi R^2 \nabla \times \vec{u}$; in the limit as $R \rightarrow 0$ the replacement becomes correct if the velocity curl is continuous. Thus, the average angular velocity component over the circle is

$$\bar{\omega}_q = \frac{1}{2} \hat{q} \cdot \nabla \times \vec{u}$$

independent of the circle size, and it follows that the angular velocity of a point in the fluid is

$$\vec{\omega}_q = \frac{1}{2} \nabla \times \vec{u} \quad (6)$$

The quantity $\nabla \times \vec{u}$ is called the vorticity.

Actually, the averaging does not need to be performed over a circular path. Thus, for an angular averaging over any path in a plane perpendicular to \hat{q} ,

$$\bar{\omega}_q = \frac{1}{2\pi} \int_0^{2\pi} \frac{\hat{q} \times \vec{r} \cdot \vec{u}}{r^2} \, d\theta$$

where θ is the angle between \vec{r} and some fixed initial value of \vec{r} . Now $\vec{r} \equiv r\hat{n}$ where \hat{n} is a unit vector which is a function of θ only; likewise, r can be considered a function of θ .

Expand \vec{u} in a series about the origin:

$$\vec{u} = \vec{u}_0 + (\vec{r} \cdot \nabla) \vec{u}_0 + \dots$$

and restrict $r(\theta)$ to be so small that the terms beyond those shown can be neglected. Then

II. DISCUSSION OF THE EQUATIONS

$$\bar{\omega}_q = \frac{1}{2\pi} \int_0^{2\pi} \hat{q} \times \hat{n} \cdot \left[\frac{\vec{u}_0}{r} + (\hat{n} \cdot \nabla) \vec{u}_0 \right] d\theta$$

Integration of the first term in the bracket gives zero, so that

$$\bar{\omega}_q = \frac{1}{2\pi} \int_0^{2\pi} \hat{q} \times \hat{n} \cdot (\hat{n} \cdot \nabla) \vec{u}_0 d\theta$$

To perform this integration, we put $\vec{R} \equiv \hat{n}R$ wherein $R = \text{constant}$. Then

$R\hat{q} \times \hat{n} d\theta \equiv d\vec{R}$ and

$$\bar{\omega}_q = \frac{1}{2\pi R} \oint \frac{(\vec{R} \cdot \nabla) \vec{u}_0 \cdot d\vec{R}}{R}$$

Now, to the same order of approximation as before, $\vec{u} \equiv \vec{u}_0 + (\vec{R} \cdot \nabla) \vec{u}_0$.

Thus,

$$\bar{\omega}_q = \frac{1}{2\pi R} \oint \frac{\vec{u} \cdot d\vec{R}}{R}$$

which is the same form as before with integration around a circle. Note that this result would not have been obtained for lengthwise averaging along an arbitrary path.

To see how the angular velocity of the field changes with time in a simple fluid, we start with the Eulerian equation

$$\frac{\partial \vec{u}}{\partial t} + (\vec{u} \cdot \nabla) \vec{u} = -\frac{1}{\rho} \nabla p$$

For a simple isentropic fluid, p is a function of ρ only, and the right side of the equation can be expressed as the gradient of a function.

Taking the curl of the equation, we obtain

$$2 \frac{\partial \vec{\omega}}{\partial t} + \nabla \times [(\vec{u} \cdot \nabla) \vec{u}] = 0$$

ANGULAR VELOCITY AND CIRCULATION

Now

$$(\vec{u} \cdot \nabla) \vec{u} = \frac{1}{2} \nabla(\vec{u} \cdot \vec{u}) - \vec{u} \times (\nabla \times \vec{u})$$

and so

$$\frac{\partial \vec{\omega}}{\partial t} = \nabla \times (\vec{u} \times \vec{\omega})$$

After expansion of the right side, this can be transformed to

$$\frac{D\vec{\omega}}{Dt} = (\vec{\omega} \cdot \nabla) \vec{u} - \vec{\omega} (\nabla \cdot \vec{u})$$

Note that if $\vec{\omega} = 0$ at some instant and at some element of the fluid, then its rate of change along the motion of the element is also zero. Thus, if $\vec{\omega} \equiv 0$ for the entire fluid at some instant, then it continues to vanish for all later times, regardless of the motion of boundaries (provided, of course, that the fluid remains isentropic).

If, at some time, the vorticity is nonzero, then it will, in general, change with time. There is, however, for a simple isentropic fluid a related invariant called the "circulation," Γ . It is defined

$$\Gamma = \oint \vec{u} \cdot d\vec{r} \quad (7)$$

where the integration is performed about some closed loop, every point of which travels with the fluid. The relation of circulation to vorticity may be demonstrated by transforming the integral to a surface integral over any continuous surface bounded by the loop. Let \hat{n} be a unit normal to the surface and da the area element. Then

II. DISCUSSION OF THE EQUATIONS

$$\Gamma = \int (\hat{n} \times \nabla) \cdot \vec{u} \, da$$

$$\Gamma = 2 \int \hat{n} \cdot \vec{\omega} \, da \quad (8)$$

To prove the invariance of Γ under the conditions stated, we differentiate along the fluid motion

$$\frac{D\Gamma}{Dt} = \oint \left(\frac{D\vec{u}}{Dt} \cdot d\vec{r} + \vec{u} \cdot \frac{Dd\vec{r}}{Dt} \right)$$

The quantity $\frac{Dd\vec{r}}{Dt}$ can be interpreted by reference to the diagram:

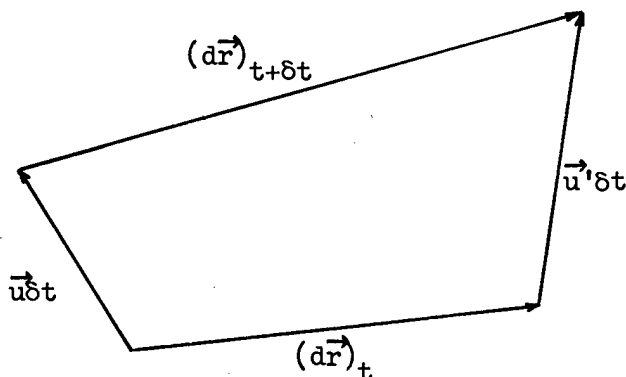

\vec{u} and \vec{u}' are the velocities at each end of $d\vec{r}$ at time t . They carry $d\vec{r}$ to a new position at time $t + \delta t$, such that

$$\vec{u}\delta t + (d\vec{r})_{t+\delta t} = \vec{u}'\delta t + (d\vec{r})_t$$

Thus,

$$\frac{Dd\vec{r}}{Dt} = \lim_{\delta t \rightarrow 0} (\vec{u}' - \vec{u})$$

Now

$$\vec{u}' = \vec{u} + (d\vec{r} \cdot \nabla) \vec{u}$$

Thus,

$$\frac{Dd\vec{r}}{Dt} = (d\vec{r} \cdot \nabla) \vec{u}$$

and

$$\vec{u} \cdot \frac{Dd\vec{r}}{Dt} = \vec{u} \cdot (d\vec{r} \cdot \nabla) \vec{u} \equiv \frac{1}{2} (d\vec{r} \cdot \nabla) (\vec{u} \cdot \vec{u})$$

Now also, $\frac{D\vec{u}}{Dt}$, for this fluid, is the gradient of some function, say ϕ (that is, $\nabla\phi = \frac{1}{\rho} \nabla p$) and so

$$\frac{D\Gamma}{Dt} = \oint \nabla \left[\frac{1}{2} (\vec{u} \cdot \vec{u}) - \phi \right] \cdot d\vec{r}$$

This can be transformed to a surface integral which will involve the curl of the integrand as a factor, and thus vanish, proving the invariance of Γ .

Note that it follows from (8) that in two-dimensional plane flow, $\vec{\omega}V$ is a fixed constant for each point moving with the fluid. This fact can also be derived as follows. In three-dimensional flow of a simple, isentropic fluid, we have seen that

$$\frac{D\vec{\omega}}{Dt} = (\vec{\omega} \cdot \nabla) \vec{u} - \vec{\omega} (\nabla \cdot \vec{u})$$

Thus

$$\frac{DV\vec{\omega}}{Dt} = \vec{\omega} \frac{DV}{Dt} + V \frac{D\vec{\omega}}{Dt} = \vec{\omega} V \nabla \cdot \vec{u} + V [(\vec{\omega} \cdot \nabla) \vec{u} - \vec{\omega} (\nabla \cdot \vec{u})] = V (\vec{\omega} \cdot \nabla) \vec{u}$$

In the special two-dimensional case, $\vec{\omega}$ is normal to the surface across which \vec{u} varies and the right side vanishes.

Angular Momentum

The angular momentum about the origin of coordinates of an element of fluid of volume $d\tau$ is

II. DISCUSSION OF THE EQUATIONS

$$d\vec{m} = \rho \vec{r} \times \vec{u} d\tau$$

so that the total for a volume V moving with the fluid (which initially occupied a volume V_0) is

$$\vec{m} = \int_V \rho \vec{r} \times \vec{u} d\tau \equiv \int_{V_0} \rho_0 \vec{r} \times \vec{u} d\tau_0$$

so that

$$\frac{d\vec{m}}{dt} = \int_{V_0} \rho_0 \left(\frac{d\vec{r}}{dt} \times \vec{u} + \vec{r} \times \frac{d\vec{u}}{dt} \right) d\tau_0$$

The first term in the parenthesis is zero. Using the momentum equation (I-8) we may put this into the form

$$\begin{aligned} \frac{d\vec{m}}{dt} &= - \int_V \vec{r} \times \nabla p d\tau \\ &\equiv \int_V \nabla \times (p\vec{r}) d\tau \end{aligned}$$

which, finally, can be transformed to the surface integral

$$\frac{d\vec{m}}{dt} = \int \hat{n} \times p\vec{r} da$$

where \hat{n} is the unit outward normal at the surface area element da .

This result shows that angular momentum of the fluid changes with time only through a surface flux; the angular momentum of an isolated fluid is identically constant.

LOCAL DECOMPOSITION OF THE VELOCITY FIELD

Local Decomposition of the Velocity Field

At any instant of time, and for any point in the fluid (chosen to be the origin of coordinates), the velocity field can be expanded in a Maclaurin series:

$$\vec{u}(\vec{r}) \equiv \vec{u}_0 + (\vec{r} \cdot \nabla) \vec{u}_0 + \mathcal{O}(r^2)$$

where $\mathcal{O}(r^2)$ means neglected terms of second or higher order.

We now introduce component notation in which i , j , and k can individually designate x , y , or z . Thus u_j can refer to u_x or u_y or u_z . In addition we shall employ the summation convention such that if any index appears twice in a term, then summation over all three coordinates is implied. Thus, for example,

$$u_j \frac{\partial u_i}{\partial x_j} \equiv u_x \frac{\partial u_i}{\partial x} + u_y \frac{\partial u_i}{\partial y} + u_z \frac{\partial u_i}{\partial z}$$

in which expression i may still be x or y or z . With this notation the Maclaurin expansion becomes

$$u_i \equiv u_{i0} + x_j \frac{\partial u_{i0}}{\partial x_j} + \mathcal{O}(r^2)$$

We now define the symmetric and antisymmetric tensors

$$D_{ij} \equiv \frac{1}{2} \left(\frac{\partial u_i}{\partial x_j} + \frac{\partial u_j}{\partial x_i} \right)$$

$$\Omega_{ij} \equiv \frac{1}{2} \left(\frac{\partial u_i}{\partial x_j} - \frac{\partial u_j}{\partial x_i} \right)$$

in terms of which

II. DISCUSSION OF THE EQUATIONS

$$u_i = u_{i0} + x_j \left(D_{ij} + \Omega_{ij} \right)_0 + \sigma(r^2)$$

The significance of D_{ij} can be seen as follows. The length of a displacement, ds , corresponding to coordinate displacements of dx , dy , and dz is given by $ds^2 = dx_i dx_i$. Now

$$\frac{D}{Dt} (dx_i) = \frac{D}{Dt} \left(\frac{\partial x_i}{\partial x_{j0}} dx_{j0} \right) = \frac{\partial u_i}{\partial x_{j0}} dx_{j0} = \frac{\partial u_i}{\partial x_j} dx_j$$

where subscript zero here means the Lagrangian coordinate, which does not change with time. Thus

$$\begin{aligned} \frac{D}{Dt} (ds^2) &\equiv 2 dx_i \frac{\partial u_i}{\partial x_j} dx_j \\ &\equiv 2 dx_j \frac{\partial u_j}{\partial x_i} dx_i \end{aligned}$$

where the two forms arise from interchanges of the dummy summation indexes. If we take the average of the two forms, we get the result

$$\frac{D}{Dt} (ds^2) = 2 D_{ij} dx_i dx_j$$

Thus, if $D_{ij} = 0$ at some point, then the length of any displacement near that point will remain constant as the point moves with the fluid. Likewise if $D_{ij} \equiv 0$ everywhere, then the fluid is perfectly rigid and its motions are limited to translation and rotation only. Local vanishing of D_{ij} also means local translation and rotation only, so that $x_j \Omega_{ij}$ is thereby interpreted as representing the rotational component, while D_{ij} represents the deformation.

PROPAGATION OF SMALL DISTURBANCES

Note that

$$x_j D_{ij} \equiv \frac{1}{2} \frac{\partial}{\partial x_i} (x_j x_k D_{jk}) + \mathcal{O}(r^2)$$

so that, with

$$D \equiv \frac{1}{2} x_j x_k D_{jk}$$

we have

$$u_i = u_{i0} + \left(\frac{\partial D}{\partial x_i} \right)_0 + (x_j \Omega_{ij})_0 + \mathcal{O}(r^2)$$

A straightforward comparison of components of $x_j \Omega_{ij}$ and the i th component of $\frac{1}{2}(\vec{\omega} \times \vec{r})$ shows that they differ by $\mathcal{O}(r^2)$ so that, finally,

$$\vec{u} \equiv \vec{u}_0 + (\nabla D)_0 + \frac{1}{2}(\vec{\omega} \times \vec{r})_0 + \mathcal{O}(r^2)$$

The velocity field has been decomposed locally into a translation, a deformation, and a rotation.

Propagation of Small Disturbances

What is the manner in which a very small disturbance is propagated through a region in which the field variables are otherwise constant? The region is isentropic so that everywhere the pressure is a function of density only,

$$p = p(\rho)$$

We use the Eulerian equations

II. DISCUSSION OF THE EQUATIONS

$$\rho \frac{\partial \vec{u}}{\partial t} + \rho (\vec{u} \cdot \nabla) \vec{u} = - \nabla p$$

$$\frac{\partial \rho}{\partial t} + \rho \nabla \cdot \vec{u} + (\vec{u} \cdot \nabla) \rho = 0$$

Define a positive quantity c (which we will here show to be the sound speed) such that

$$c = \sqrt{\frac{dp(\rho)}{d\rho}} \quad (9)$$

and also substitute

$$\vec{u} \rightarrow \vec{u}_0 + \vec{u}_1$$

$$\rho \rightarrow \rho_0 + \rho_1$$

$$c \rightarrow c_0 + c_1$$

where ρ_0 , \vec{u}_0 , and c_0 characterize the undisturbed field, and ρ_1 , \vec{u}_1 , and c_1 are relatively very small perturbations. Then the equations become, to lowest order in the perturbations,

$$\rho_0 \frac{\partial \vec{u}_1}{\partial t} + \rho_0 (\vec{u}_0 \cdot \nabla) \vec{u}_1 = - c_0^2 \nabla \rho_1$$

$$\frac{\partial \rho_1}{\partial t} + \rho_0 \nabla \cdot \vec{u}_1 + (\vec{u}_0 \cdot \nabla) \rho_1 = 0$$

We now transfer to a coordinate system moving with velocity \vec{u}_0 relative to the original fixed system. In this new coordinate system, the equations become

SOUND WAVES IN A VARIABLE-DENSITY ATMOSPHERE

$$\rho_0 \frac{\partial \vec{u}_1}{\partial t} = -c_0^2 \nabla \rho_1$$

$$\frac{\partial \rho_1}{\partial t} = -\rho_0 \nabla \cdot \vec{u}_1$$

From these two equations \vec{u}_1 can be eliminated, giving

$$\frac{\partial^2 \rho_1}{\partial t^2} - c_0^2 \nabla^2 \rho_1 = 0$$

This is the familiar wave equation, for which the general solutions are waves propagating with speed c_0 . Thus small disturbances are propagated relative to the moving fluid with speed c_0 .

For a polytropic gas, for example,

$$c = \sqrt{\frac{\gamma p}{\rho}} = \sqrt{\gamma(\gamma - 1)I} = \sqrt{\gamma NRT} \quad (10)$$

In general, c^2 is the constant-entropy pressure derivative with respect to density:

$$c^2 \equiv \left(\frac{\partial p}{\partial \rho} \right)_S \equiv \text{constant}$$

With a general equation of state in the form $I = I(p, \rho)$, the formula for sound speed can thus be written

$$c^2 = \frac{p - \rho^2 \frac{\partial I}{\partial \rho}}{\rho^2 \frac{\partial I}{\partial p}}$$

Sound Waves in a Variable-Density Atmosphere

The time-independent solution of the one-dimensional Eulerian

II. DISCUSSION OF THE EQUATIONS

equations with external acceleration

$$\rho \frac{\partial u}{\partial t} + \rho u \frac{\partial u}{\partial x} = -c^2 \frac{\partial \rho}{\partial x} + \rho g(x)$$

$$\frac{\partial \rho}{\partial t} + \rho \frac{\partial u}{\partial x} + u \frac{\partial \rho}{\partial x} = 0$$

gives the equilibrium state of a variable density fluid. We assume that the sound speed is constant. Then the equilibrium solution is given as

$$u_e(x) = 0$$

$$\rho_e(x) = \rho_0 \exp\left[\frac{1}{c^2} \int_0^x g(x') dx'\right]$$

which includes the boundary condition $\rho_e = \rho_0$ at $x = 0$. We look for solutions differing only slightly from the equilibrium state

$$u \ll c$$

$$\rho = \rho_e(x) e^\epsilon, \quad \epsilon \ll 1$$

Substitution of these into the equations and elimination of all but lowest order terms lead to

$$\frac{\partial \epsilon}{\partial t} + \frac{\partial u}{\partial x} = -\frac{u}{\rho_e} \frac{\partial \rho_e}{\partial x}$$

$$\frac{\partial u}{\partial t} + c^2 \frac{\partial \epsilon}{\partial x} = 0$$

Note that if ρ_e is constant, then these become the wave equation with signal speed c .

SOUND WAVES IN A VARIABLE-DENSITY ATMOSPHERE

Consider the special case in which $g(x) \equiv \text{constant}$. Then

$$\rho_e(x) = \rho_0 e^{gx/c^2}$$

and the equations, with ϵ eliminated, become

$$\frac{\partial^2 u}{\partial t^2} - c^2 \frac{\partial^2 u}{\partial x^2} - g \frac{\partial u}{\partial x} = 0$$

Substitution of the progressive-wave solution

$$u = A e^{i\alpha x} e^{i\omega t}$$

shows that the condition for solution is

$$\omega^2 = \alpha^2 c^2 - ig\alpha$$

and that A is an arbitrary constant, with dimensions of velocity (whose magnitude, of course, must be much less than c for validity of the perturbation approximation). If the wave length of the signal is small compared with the distance over which ρ_e/ρ_0 changes appreciably, then ω can be approximated by

$$\omega \approx \pm \left(\alpha c - \frac{ig}{2c} \right)$$

Thus ω has an imaginary part, corresponding to a change in amplitude of the wave; as the wave moves in the direction of decreasing density, its amplitude increases, and vice versa. Along the line $x = \bar{+} ct$, $u = A \exp(-gx/2c^2)$ so that, along the motion of the signal, ρu^2 is constant.

CHAPTER III

CHARACTERISTIC SOLUTIONS AND SIMPLE WAVES

Characteristics

One of the most powerful methods for obtaining solutions of the one-dimensional hydrodynamic equations is called the method of characteristics. As an example of its application, consider the problem of solving the one-dimensional Eulerian equations for a simple, isentropic gas

$$\rho \frac{\partial u}{\partial t} + \rho u \frac{\partial u}{\partial x} = -c^2 \frac{\partial \rho}{\partial x} \quad (1)$$

$$\frac{\partial \rho}{\partial t} + u \frac{\partial \rho}{\partial x} = -\rho \frac{\partial u}{\partial x}$$

The sound speed, c , is a function of the density, so that we may introduce a new function, σ , defined, to within an arbitrary constant, by

$$d\sigma = \frac{cd\rho}{\rho} \quad (2)$$

Then (1) becomes

$$\frac{\partial u}{\partial t} + u \frac{\partial u}{\partial x} + c \frac{\partial \sigma}{\partial x} = 0 \quad (3)$$

$$\frac{\partial \sigma}{\partial t} + u \frac{\partial \sigma}{\partial x} + c \frac{\partial u}{\partial x} = 0$$

CHARACTERISTICS

wherein c is now considered to be a known function of σ . By summing or differencing these equations, one obtains

$$\frac{\partial}{\partial t} (u + \sigma) + (u + c) \frac{\partial}{\partial x} (u + \sigma) = 0 \quad (4)$$

$$\frac{\partial}{\partial t} (u - \sigma) + (u - c) \frac{\partial}{\partial x} (u - \sigma) = 0$$

From the first equation, one can see that along a line in the x - t plane such that $dx/dt = u + c$, the quantity $(u + \sigma)$ is a perfect differential and the equation can be integrated. With a similar result from the second equation we may write

$$u + \sigma = \text{constant, along } \frac{dx}{dt} = u + c \quad (5)$$

$$u - \sigma = \text{constant, along } \frac{dx}{dt} = u - c$$

These are the characteristic solutions, and the families of lines $dx/dt = u \pm c$ are called the characteristic lines, or simply, the characteristics.

These characteristic solutions are not, in general, complete; they do not necessarily allow the features of any applicable flow field to be determined directly. They are, however, extremely powerful aids in obtaining solutions in certain special cases, or in cases when parts of the solution can be obtained by other means.

As an example of the use of the characteristic solutions, consider the problem of determining the effect on a gas, initially

III. CHARACTERISTIC SOLUTIONS AND SIMPLE WAVES

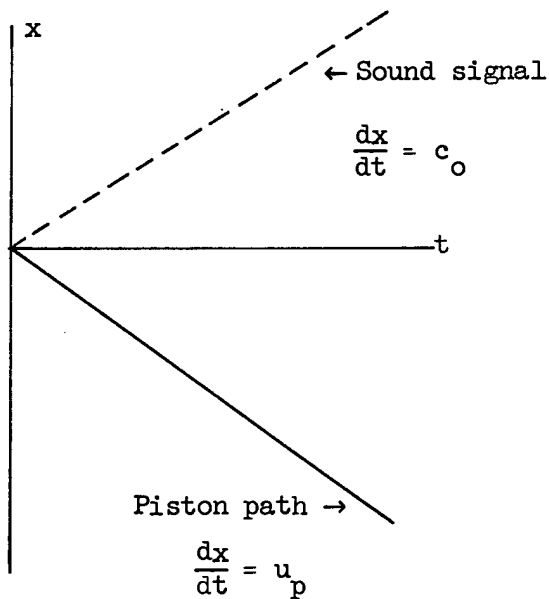

at rest, of a piston being withdrawn from it. Up to $t = 0$, there is a piston at $x = 0$, and gas at rest for $x > 0$. At $t = 0$, the piston commences to move with uniform velocity, u_p , in the negative x -direction, and a sound signal proceeds into the gas. We now attempt to connect the sound signal and piston-path lines with a family of

characteristic lines. The line $dx/dt = u + c$ is of no use, since along the sound signal, $u = 0$, and the characteristic lies along the signal line. The line $dx/dt = u - c$, on the other hand, has negative slope at the sound signal line, hence intersects it. Furthermore, this characteristic has negative slope throughout the flow field between the sound signal and the piston path, because $u < 0$ and $c \geq 0$. Also, the slope is more negative than that of the piston path, assuming that $c \neq 0$ anywhere within the flow field of interest, so that each characteristic $dx/dt = u - c$ will also intersect the piston path. Thus

$$u_0 - \sigma_0 = u_p - \sigma_p$$

or, since $u_0 = 0$,

$$\sigma_p = u_p + \sigma_0 \tag{6}$$

For a polytropic gas, for example, $\sigma \equiv 2c/(\gamma - 1)$, so that

CHARACTERISTICS

$$c_p = \frac{\gamma - 1}{2} u_p + c_o$$

Since $u_p < 0$, the sound speed is less than c_o at the piston; the more negative the piston speed, the smaller would be the sound speed there. This fact makes plausible the assumption that $c \neq 0$ in the flow field, with the exception being the case in which $c_p = 0$. If the piston is withdrawn any faster than the critical speed at which $c_p = 0$, then the gas cannot follow; a vacuum occurs between the escaping gas front and the piston. This critical piston speed — called the escape speed of the gas — is

$$u_{\text{escape}} = - \frac{2c_o}{\gamma - 1} \quad (7)$$

Notice that c_p is independent of time, simply because u_p and c_o are independent of time. It does not matter where the two intersection points are along the sound-signal and piston paths.

The method of solution is also valid if u_p varies with time, as long as a shock does not interfere with the characteristic line.

(Note: If the piston velocity persists for sufficient time at values less negative than any which it has previously attained, then a shock will form.)

An interesting generalization of this problem can also be solved by the method of characteristics. Suppose that the piston is replaced by a wall which has mass per unit area m . Up to $t = 0$, the wall is held fixed at $x = 0$; it is then released and moves away because of the

III. CHARACTERISTIC SOLUTIONS AND SIMPLE WAVES

gas pressure exerted on it. What is the history of its motion? Let subscript w refer to conditions at the movable wall. Then

$$m \frac{du_w}{dt} = -p_w$$

The characteristic equation (6) is again applicable; in terms of sound speed,

$$u_w = \frac{2}{\gamma - 1} (c_w - c_o)$$

Now

$$c_w = c_o \left(\frac{p_w}{p_o} \right)^{\frac{\gamma-1}{2\gamma}}$$

so that we now have three equations for determination of the three unknowns, u_w , p_w , and c_w . There is one constant of integration to be determined in the solution; for this we specify that $u_w = 0$ at $t = 0$.

Then the solution, after some manipulation, is found to be

$$u_w = -\frac{2 c_o}{\gamma - 1} \left[1 - \Xi^{-\left(\frac{\gamma-1}{\gamma+1}\right)} \right]$$

$$p_w = p_o \Xi^{-\left(\frac{2\gamma}{\gamma+1}\right)}$$

$$c_w = c_o \Xi^{-\left(\frac{\gamma-1}{\gamma+1}\right)}$$

where

$$\Xi \equiv 1 + \left(\frac{\gamma+1}{2\gamma} \right) \left(\frac{\rho_o c_o t}{m} \right)$$

Thus as $t \rightarrow \infty$, u_w approaches the gas escape speed; the wall mass only affects the rate at which the final speed is approached.

Simple Waves

Suppose that in some region of the $x-t$ plane the flow field is in a constant state: $u = u_0$, $\sigma = \sigma_0$ everywhere within the region. The constant-state region can be bounded above and/or below by regions in which the flow field is not constant. The boundary lines will either be shocks, or else they will be straight characteristics. If they are not shocks, then the boundaries of the nonconstant regions (the disturbance boundaries) will propagate into the constant-state region with sound speed relative to the material, and thus will have slope $u_0 \pm c_0$, being, therefore, straight characteristics.

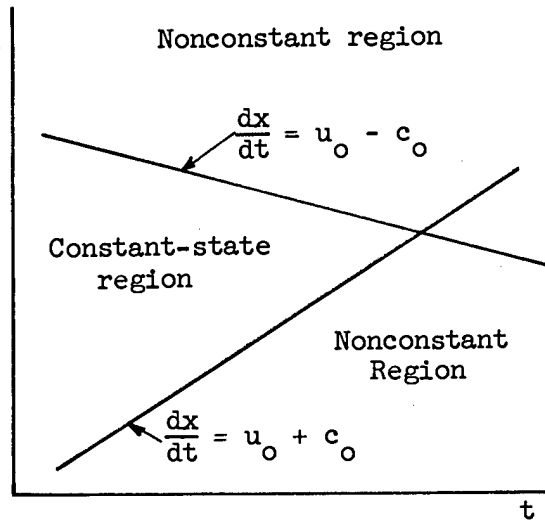

The most important fact, now to be established, is that the flow in the adjacent regions will always be of a particularly simple form. Consider first the lower nonconstant region. Through it will pass the family of characteristics $dx/dt = u - c$, which, at the disturbance boundary, have slope $u_0 - c_0$, and hence intersect it as long as $c_0 \neq 0$. Along each of these characteristics $u - \sigma$ is constant; indeed, $u - \sigma$ will be the same constant for all members of the family of characteristics which intersect the disturbance boundary, since along that boundary the constant is $u_0 - \sigma_0$. Thus, throughout the region adjacent to the region of constant state, $u - \sigma$ will be one fixed constant. Likewise,

III. CHARACTERISTIC SOLUTIONS AND SIMPLE WAVES

one can prove that throughout the nonconstant region above the region of constant state, $u + \sigma$ will be one fixed constant. Any region in which $u + \sigma$ or $u - \sigma$ is a fixed constant throughout is referred to as the region of a "simple wave." The extent of the region of a simple wave adjacent to a region of constant state is limited by the requirement of contact with the disturbance line through a characteristic.

In the case that $c_0 = 0$, no infinitesimal disturbance can propagate into the constant-state region; any wave propagating into the region must therefore have finite amplitude at its front. Such a discontinuous disturbance is a shock and requires separate treatment.

Consider now the example of a simple wave propagating in the positive x direction into a constant-state region in which $u_0 = 0$.

Then

$$u - \sigma \equiv -\sigma_0$$

and the two equations in (3) become the same,

$$\frac{\partial \sigma}{\partial t} + (\sigma - \sigma_0 + c) \frac{\partial \sigma}{\partial x} = 0$$

which has the general solution

$$\sigma = F[x - (\sigma - \sigma_0 + c)t]$$

or

$$\left. \begin{aligned} \sigma &= F[x - (u + c)t] \\ u &= \sigma - \sigma_0 \end{aligned} \right\} \quad (8)$$

wherein F is an arbitrary function of its argument.

As an example of the use of this solution, consider the problem of determining the motion of a polytropic gas disturbed by a piston. It is assumed that up to $t = 0$ the piston is at rest, so that a semi-infinite region of constant state, with $u = 0$, $\sigma = \sigma_0$, has been established. Subsequent to $t = 0$, the piston moves with prescribed velocity $v(t)$ to positions $x(t)$ (such that $v = dx/dt$). For a polytropic gas, $\sigma \equiv 2c/(\gamma - 1)$, so that (8) can be written

$$\left. \begin{aligned} \text{or} \quad \frac{2c_0}{\gamma - 1} + u &= F\left[x - \left(c_0 + \frac{\gamma + 1}{2}u\right)t\right] \\ \frac{2c}{\gamma - 1} &= F\left[x - \frac{\gamma + 1}{\gamma - 1}\left(c - \frac{2c_0}{\gamma + 1}\right)t\right] \\ \text{and} \quad u &= \frac{2}{\gamma - 1}(c - c_0) \end{aligned} \right\} \quad (9)$$

Thus, the function F is to be determined by substituting into (9) the known conditions at the piston

$$\frac{2c_0}{\gamma - 1} = F(-c_0 t) \quad t < 0 \quad (10)$$

$$\frac{2c_0}{\gamma - 1} + v = F\left[x - \left(c_0 + \frac{\gamma + 1}{2}v\right)t\right] \quad t > 0$$

and $F(0)$ lies between $2c_0/(\gamma - 1)$ and $2c_0/(\gamma - 1) + v$.

III. CHARACTERISTIC SOLUTIONS AND SIMPLE WAVES

Example I

The problem of withdrawal of the piston at constant speed was partially solved earlier in the chapter. Here we may solve it completely. (The same problem is solved more easily in Chapter V; we use this method here for illustration, because of its power for more complicated problems which cannot be treated by the procedure of Chapter V.) In this case, v is a constant ($v < 0$) and $x = vt$. From (10)

$$F(\xi) = \frac{2c_0}{\gamma - 1} \quad \xi > 0$$

$$F(\xi) = \frac{2c_0}{\gamma - 1} + v \quad \xi < 0$$

where ξ is any argument of F .

This solution, put into (9), becomes

$$\left. \begin{aligned} \frac{2c}{\gamma - 1} &= \frac{2c_0}{\gamma - 1} \quad \text{for } x - \frac{\gamma + 1}{\gamma - 1} \left(c - \frac{2c_0}{\gamma + 1} \right) t > 0 \\ \frac{2c}{\gamma - 1} &= \frac{2c_0}{\gamma - 1} + v \quad \text{for } x - \frac{\gamma + 1}{\gamma - 1} \left(c - \frac{2c_0}{\gamma + 1} \right) t < 0 \end{aligned} \right\} \quad (11)$$

or

$$\left. \begin{aligned} c &= c_0 \quad \text{for } x > c_0 t \\ \frac{2c}{\gamma - 1} &= \frac{2c_0}{\gamma - 1} + v \quad \text{for } x < \left(c_0 + \frac{\gamma + 1}{2} v \right) t \end{aligned} \right\} \quad (12)$$

The first statement says that the signal propagates with sound speed.

The second one states that between the piston and the path given by

$x = \left(c_0 + \frac{(\gamma + 1)}{2} v \right) t$, the sound speed is a constant, and the result is

SIMPLE WAVES

identical to that in (6) for conditions at the piston. (Note that if $v = - [2c_0/(\gamma - 1)]$, the escape speed, then the thickness of the constant-state zone next to the piston is zero, since its boundaries both move with piston speed.)

Finally, in addition to (11) we have

$$\frac{2c_0}{\gamma - 1} + v < \frac{2c}{\gamma - 1} < \frac{2c_0}{\gamma - 1} \quad \text{for} \quad x - \frac{\gamma + 1}{\gamma - 1} \left(c - \frac{2c_0}{\gamma + 1} \right) t = 0$$

or

$$\left. \begin{aligned} c &= \frac{\gamma - 1}{\gamma + 1} \left(\frac{2c_0}{\gamma - 1} + \frac{x}{t} \right) \\ \text{and, from (9),} \\ u &= \frac{2}{\gamma + 1} \left(\frac{x}{t} - c_0 \right) \end{aligned} \right\} \quad \text{for } c_0 + \frac{\gamma + 1}{2} v < \frac{x}{t} < c_0 \quad (13)$$

Example II

From (9) may be calculated the instantaneous slope of the function $c(x,t)$:

$$\frac{\partial c}{\partial x} = \frac{(\gamma - 1) F' \left[x - \frac{\gamma + 1}{\gamma - 1} \left(c - \frac{2c_0}{\gamma + 1} \right) t \right]}{2 + (\gamma + 1)t F' \left[x - \frac{\gamma + 1}{\gamma - 1} \left(c - \frac{2c_0}{\gamma + 1} \right) t \right]} \quad (14)$$

where F' means the derivative of F with respect to its argument. Thus, if $F(x)$ has negative slope at any time, then the denominator may eventually vanish; the result is a shock.

As a specific example, consider the problem of determining the

III. CHARACTERISTIC SOLUTIONS AND SIMPLE WAVES

effect of a uniformly accelerating piston, moving into the gas. In this, with acceleration a ,

$$\begin{aligned} v &= at \\ x &= \frac{1}{2} at^2 \end{aligned}$$

and (10) becomes

$$\left. \begin{aligned} F(\xi) &= \frac{2c_0}{\gamma - 1} & \xi > 0 \\ F\left[\frac{1}{2} at^2 - \left(c_0 + \frac{\gamma + 1}{2} at\right)t\right] &= \frac{2c_0}{\gamma - 1} + at & t > 0 \end{aligned} \right\} \quad (15)$$

We set the argument of F equal to ξ in the second equation of (15) and solve for t

$$t = -\frac{c_0}{\gamma a} + \frac{1}{\gamma a} \sqrt{c_0^2 - 2\gamma a \xi}$$

where the sign has been chosen such that $t = 0$ when $\xi = 0$. Thus

$$\left. \begin{aligned} F(\xi) &= \frac{\gamma + 1}{\gamma(\gamma - 1)} c_0 + \frac{1}{\gamma} \sqrt{c_0^2 - 2\gamma a \xi} & \xi < 0 \\ F(\xi) &= \frac{2c_0}{\gamma - 1} & \xi > 0 \end{aligned} \right\} \quad (16)$$

Combining this with (9), we obtain

$$\left. \begin{aligned} \frac{2c}{\gamma - 1} &= \frac{\gamma + 1}{\gamma(\gamma - 1)} c_0 + \frac{1}{\gamma} \sqrt{c_0^2 - 2\gamma a \left[x - \frac{\gamma + 1}{\gamma - 1} \left(c - \frac{2c_0}{\gamma + 1} \right) t \right]} & x < c_0 t \\ &= \frac{2c_0}{\gamma - 1} & x > c_0 t \end{aligned} \right\} \quad (17)$$

(The condition $x < c_0 t$ in the first equation follows from the condition $x - (\gamma + 1)/(\gamma - 1) [c - [2c_0/(\gamma + 1)]] t < 0$. This can be verified by

noting that at the point $x = c_0 t$, $c = c_0$ in the solution that follows.)

The equations (17) can be solved for c :

$$\left. \begin{aligned}
 c &= \frac{\gamma+1}{2\gamma} (c_0 + \frac{\gamma-1}{2} at) \\
 &\quad + \frac{\gamma-1}{2\gamma} \sqrt{c_0^2 + (\gamma-1)a c_0 t - 2\gamma ax + (\frac{\gamma+1}{2})^2 a^2 t^2} \quad x < c_0 t \\
 c &= c_0 \quad x > c_0 t
 \end{aligned} \right\} \quad (18)$$

(As a check on this solution, it may be noted that at the piston, where $x = 1/2 at^2$, (18) gives $2c/(\gamma-1) = 2c_0/(\gamma-1) + at$, being the result obtained previously — see (6), which is perfectly valid for a piston speed varying with time.)

The envelope in the $x-t$ plane, of values such that the square root vanishes in (18), is a path of particular interest. Along it, $\partial c/\partial x$ is infinite so that the path defines a shock, whose position $x_s(t)$ is given by

$$x_s(t) = \frac{1}{2\gamma a} \left[c_0^2 + (\gamma-1)a c_0 t + (\frac{\gamma+1}{2})^2 a^2 t^2 \right] \quad (19)$$

This is valid, however, only for $x_s \leq c_0 t$, or for $t \geq 2c_0/(\gamma+1)a$.

Hence a shock forms at time and position

$$t_s = \frac{2c_0}{(\gamma+1)a}, \quad x_s = \frac{2c_0^2}{(\gamma+1)a} \quad (20)$$

and proceeds initially with speed c_0 . The solution cannot, however, be believed after the initial formation of the shock, since thereafter the flow pattern is no longer that of a simple wave.

CHAPTER IV

SHOCKS

Description of a Shock

The compressive-piston problem of Chapter III shows that there are circumstances in which the differential equations predict the flow field of a fluid to develop a discontinuity, or shock. So far, we have not discussed any procedure for handling such circumstances; the differential equations become meaningless at a shock and offer no clue for subsequent treatment of the discontinuity whose formation they predict.

The concept of a discontinuous shock is very useful, even though the field does not become really discontinuous. Actually, where the differential equations predict formation of a discontinuity, a very thin region is formed over which the field variables change extremely rapidly. The structure of these regions is discussed in Chapter IX, where it is shown that the inclusion of viscosity effects in the differential equations removes the tendency for the equations to predict discontinuities. It is further shown, for example, that shocks in air are commonly a small fraction of a millimeter in thickness, so that in a study of interaction with large bodies, the discontinuous approximation may be very good.

DESCRIPTION OF A SHOCK

There are two types of surface discontinuities which may occur. One of these, called a "contact discontinuity," moves with the fluid. It is present at the boundary between two kinds of fluid, and it may also be generated within one fluid under certain circumstances. It is characterized by the continuity of pressure and of normal velocity component across it.

The other type of discontinuity, the shock, moves relative to the fluid, changing the state of each element as it sweeps by. To see the manner in which this occurs, it is sufficient to consider a relatively simple case: The shock is an infinite flat plane separating two semi-infinite regions in each of which the state is everywhere the same and in which the material velocities are normal to the shock plane. The results will be instantaneously appropriate for curved shocks with non-constant adjacent states as long as the material speed is everywhere normal to the shock. The reason is that in considering a shock to be of zero thickness, the vicinity of a point on it can be examined "microscopically" to a sufficient degree to give the vicinity of the point the idealized conditions described.

We use the notation in the diagram; the shock is moving to the right and the fluid is more compressed on the left. In general, the shock speed, v , is greater than the material speed on either side. Also $u_- > u_+$ (for a shock traveling as pictured), which follows from the fact that the

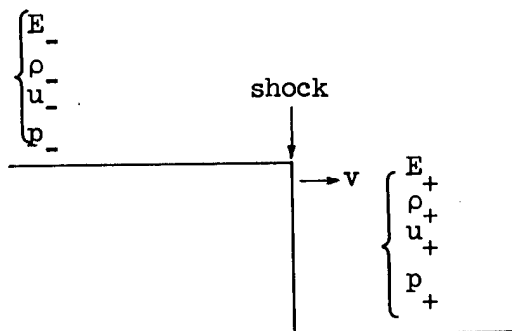

IV. SHOCKS

shock is compressive. (We shall show in this chapter that all shocks are compressive.) Four conditions exist which relate changes of these variables across the shock. One of these is the equation of state. The other three, called the Rankine-Hugoniot relations, are derived as consequences of the three fundamental conservation laws. It will be useful to examine several derivations of these relations.

Fundamental Derivation of the Shock Relations

1. Conservation of Mass. The distance per unit time that material moves relative to the shock is $(v - u_+)$ on the right and $(v - u_-)$ on the left. The mass per unit area of shock per unit time, m , which passes into the shock from the right, is thus $m = \rho_+(v - u_+)$. This must, however, be exactly the same as the mass per unit time which leaves the shock to the left:

$$m \equiv \rho_+(v - u_+) = \rho_-(v - u_-) \quad (1)$$

2. Conservation of Momentum. The momentum per unit area per unit time passing into the shock from the right is $m u_+$; similarly, that which leaves from the left is $m u_-$ so that the change in momentum per unit time is $m (u_- - u_+)$. This must equal the force per unit area on the system:

$$m (u_- - u_+) = p_- - p_+ \quad (2)$$

3. Conservation of Energy. The energy change per unit area per unit time is $m (E_- - E_+)$. This must be equal to the net rate of doing

INTEGRAL DERIVATION OF THE SHOCK RELATIONS

work on the region:

$$m(E_- - E_+) = p_- u_- - p_+ u_+ \quad (3)$$

These simple results will be extremely useful for exploring a number of interesting hydrodynamic situations. For convenience in handling the shock relations, we introduce the notation for each field variable

$$\left. \begin{aligned} \delta\psi &\equiv \psi_+ - \psi_- \\ \bar{\psi} &\equiv \frac{1}{2} (\psi_+ + \psi_-) \end{aligned} \right\} \quad (4)$$

where ψ stands for any of the field variables. The following identity occasionally will be useful:

$$\delta(\psi_1 \psi_2) \equiv \bar{\psi}_1 \delta\psi_2 + \bar{\psi}_2 \delta\psi_1 \quad (5)$$

In terms of these symbols, the shock relations can be put into the form

$$m \equiv v\bar{\rho} - \bar{\rho}u \quad (6)$$

$$v\delta\rho = \delta(\rho u) \quad (7)$$

$$m \delta u = \delta p \quad (8)$$

$$m \delta E = \delta(pu) \quad (9)$$

Integral Derivation of the Shock Relations

In Chapter I, it was shown that the equations could be expressed in integral form (I-26), (I-27). We now assume that the equations thus written are valid even in the presence of a shock. A posteriori justification of this assumption will follow from the fact that the results of the following analysis are correct.

IV. SHOCKS

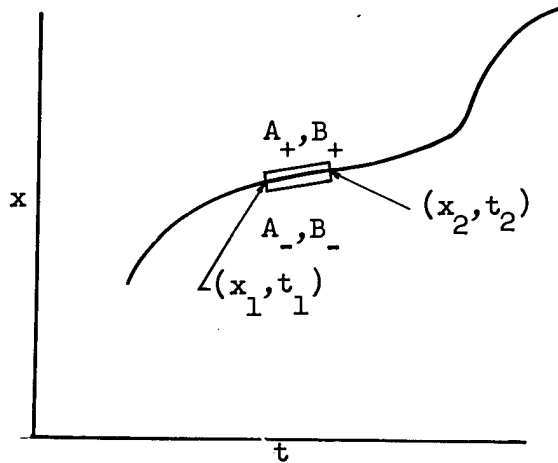

The line in the diagram is a plot of shock position versus time, with the shock moving in the positive x-direction. Draw a rectangle about a segment of the curve in the vicinity of a point of interest.

The rectangle is to be considered so narrow, in a direction normal to the curve, that contributions to an integral around the rectangle due to its ends will be negligible.

The rectangle cuts the shock curve at (x_1, t_1) and (x_2, t_2) . The integral equation for a path around the rectangle is thus (see page 30)

$$A_-(x_2 - x_1) - B_-(t_2 - t_1) + A_+(x_1 - x_2) - B_+(t_1 - t_2) = 0$$

(where higher order contributions due to finite rectangle size have been neglected). If, now, the rectangle is sufficiently short, then $(x_2 - x_1)/(t_2 - t_1)$ differs negligibly from the speed of the shock, v . Thus, the result from the integral equation is

$$v\delta A - \delta B = 0 \tag{10}$$

From the conservative Eulerian equations, (I-26) we obtain

$$\left. \begin{aligned} v\delta\rho &= \delta(\rho u) \\ v\delta(\rho u) &= \delta(\rho u^2 + p) \\ v\delta(\rho E) &= \delta(\rho Eu + pu) \end{aligned} \right\} \tag{11}$$

DISCUSSION OF SHOCK FORMATION

The first of these is identical with the previous result (7). It can be shown that all three of them are reducible to the results obtained from the fundamental derivation.

From the conservative Lagrangian equations, (I-27), we obtain

$$v' \rho_0 \delta \left(\frac{1}{\rho} \right) = - \delta u$$

$$v' \rho_0 \delta u = \delta p$$

$$v' \rho_0 \delta E = \delta(pu)$$

where v' is the Lagrangian shock speed (that is, the speed of the shock relative to the unshocked material). The quantity $v' \rho_0$ is just equal to m , the mass per unit area per unit time passing across the shock.

Thus

$$\left. \begin{aligned} m \delta \left(\frac{1}{\rho} \right) &= - \delta u \\ M \delta u &= \delta p \\ M \delta E &= \delta(pu) \end{aligned} \right\} \quad (12)$$

Through the Eulerian definition of m in (6), it can be shown that (11) and (12) are equivalent. The fundamental derivation produced the first equation of (11) and the second two of (12). This auxiliary integral method of derivation produced the other forms shown, which will be useful.

Discussion of Shock Formation

It was shown in Chapter III that the compressive motion of a piston is likely to cause a shock. Here we examine in more detail the

IV. SHOCKS

basis for this peculiar phenomenon. There are two processes which contribute to the formation of a shock. Consider, for example, the compressive motion of a piston. In the pulse adjacent to the piston, the fluid is moving towards the undisturbed fluid which is further away. Signals from the piston, indicating its approach, are propagated with sound speed relative to the moving material. Thus, relative to a fixed reference frame, signals approach the pulse front faster than it moves through the undisturbed fluid. These signals pile up, producing the shock. The second process which also contributes to the shock formation is the heating of the pulse adjacent to the piston. This heating also increases the sound speed over that in the undisturbed region.

Both of these processes are manifested mathematically by the non-linear character of the differential equations. Thus, for example, in the simple-wave equation of Chapter III,

$$\frac{\partial \sigma}{\partial t} + (\sigma - \sigma_0 + c) \frac{\partial \sigma}{\partial x} = 0$$

the nonlinearity arises from the presence in the parentheses of σ (producing the first shock-forming process) and of $c(\sigma)$ (producing the second shock-forming process). If we linearize the equation by putting $\sigma = \sigma_0$ and $c = c_0$, the general solution is that of a propagating pulse whose shape does not change with time

$$\sigma = F(x - c_0 t)$$

However, the more general solution, as shown in Eq. (III-14), can lead to shock formation.

SHOCK RELATIONS FOR SPECIAL CASES

Usually, the formation of a shock makes the theoretical treatment of a problem much more difficult. The shock is a moving boundary, along which boundary conditions can be supplied, but whose motion with time is not a priori known. In addition, the fluid may no longer be isentropic (as will be shown later). As a result, analytical solutions in the presence of variable shocks are very difficult to obtain except in certain special cases (see, for example, Chapter VI).

Shock Relations for Special Cases

Probably the three most useful of the general forms of the shock relations (obtainable by putting $E = I + 1/2 u^2$ and eliminating m from the shock relations) are

$$\left. \begin{aligned} v\delta\rho &= \delta(\rho u) \\ (\delta p)\left(\delta \frac{1}{\rho}\right) &= -(\delta u)^2 \\ \delta I &= -\bar{p}\delta\left(\frac{1}{\rho}\right) \end{aligned} \right\} \quad (13)$$

In particular, if the coordinate system is such that $u_+ = 0$, then

$$v(\rho_- - \rho_+) = \rho_- u_- \quad (14)$$

$$(p_- - p_+)(\rho_- - \rho_+) = \rho_- \rho_+ u_-^2 \quad (15)$$

$$I_- - I_+ = \frac{p_- + p_+}{2\rho_- \rho_+} (\rho_- - \rho_+) \quad (16)$$

In the special case that the gas is polytropic, these equations can be rewritten in a number of convenient forms. Let c_- and c_+ be the sound speeds behind and ahead of the shock, respectively, and define

IV. SHOCKS

$$M \equiv \frac{v}{c_+}$$

$$U \equiv \frac{u}{c_+}$$

$$Z \equiv \frac{p_-}{p_+}$$

$$P \equiv \frac{p_-}{p_+}$$

$$M' \equiv \frac{u}{c_-}$$

Relative to the gas ahead of the shock, M and U are, respectively, the Mach numbers of the shock and of a piston producing it. M' is the Mach number for the flow behind the shock. It follows from the shock relations that U , Z , P , and M' are all functions of M alone. Thus

$$U = \frac{2(M^2 - 1)}{(\gamma + 1)M} \quad (17)$$

$$Z = \frac{\gamma + 1}{\gamma - 1 + (2/M^2)} \quad (18)$$

$$P = 1 + \frac{2\gamma}{\gamma + 1} (M^2 - 1) \quad (19)$$

$$M' = \frac{2(M^2 - 1)}{M \sqrt{[\gamma - 1 + (2/M^2)](2\gamma M^2 - \gamma + 1)}} \quad (20)$$

or, conversely,

$$M = \frac{\gamma + 1}{4} U + \sqrt{1 + \left(\frac{\gamma + 1}{4} U\right)^2} \quad (21)$$

SHOCK RELATIONS FOR SPECIAL CASES

$$M^2 = \frac{2Z}{\gamma + 1 - (\gamma - 1)Z} \quad (22)$$

$$M^2 = 1 + \frac{\gamma + 1}{2\gamma} (P - 1) \quad (23)$$

$$M^2 = \frac{-8 + (\gamma^2 - 6\gamma + 1)(M')^2 - 4(\gamma + 1)M' \sqrt{1 + [(\gamma + 1)/4]^2 (M')^2}}{4\gamma(\gamma - 1)(M')^2 - 8} \quad (24)$$

If the shock is very strong (that is, the shock speed is large compared with the sound speed ahead) then $M \rightarrow \infty$ and

$$\frac{U}{M} \rightarrow \frac{2}{\gamma + 1}$$

$$Z \rightarrow \frac{\gamma + 1}{\gamma - 1}$$

$$\frac{P}{M^2} \rightarrow \frac{2\gamma}{\gamma + 1}$$

$$M' \rightarrow \sqrt{\frac{2}{\gamma(\gamma - 1)}}$$

Thus, for an infinite-strength shock,

1. The shock speed is determined by the gas speed behind. If the shock is formed by a piston moving with uniform speed, then the material speed behind the shock equals the piston speed and

$$u_p = \frac{2}{\gamma + 1} v$$

2. The compression produced by the shock is independent of the

IV. SHOCKS

shock speed and depends only on the nature of the gas. Notice from (18) that the greatest possible compression that can be produced by a shock in a polytropic gas is $(\gamma + 1)/(\gamma - 1)$. For air, for example, $\gamma = 1.4$ so that the greatest possible shock compression in air is 6.

3. The maximum Mach number for the flow behind a shock moving into a polytropic gas at rest is a function of the value of γ only. For air, this limit is 1.89.

The relations for an infinite strength shock can be summarized in more convenient forms

$$\left. \begin{aligned} \frac{\rho_-}{\rho_+} &= \frac{\gamma + 1}{\gamma - 1} \\ v &= \frac{\gamma + 1}{2} u_- \\ I_- &= \frac{1}{2} u_-^2 \\ p_- &= \rho_- u_-^2 \left(\frac{\gamma - 1}{2} \right) = \rho_+ v^2 \left(\frac{2}{\gamma + 1} \right) \\ u_- &= c_- \sqrt{\frac{2}{\gamma(\gamma - 1)}} \end{aligned} \right\} \quad (25)$$

Note from the third of these that there is equal partition between internal and kinetic energy behind an infinite strength shock. Note also that for most real gases, which often can be considered polytropic with $\gamma < 2$, the material speed behind the infinite strength shock is greater than the sound speed.

ENTROPY CHANGE ACROSS A SHOCK

Entropy Change Across a Shock

The entropy change across a shock in a polytropic gas is, according to (II-5),

$$S_- - S_+ = b \left[\ln \left(\frac{p_-}{p_+} \right) - \gamma \ln \left(\frac{\rho_-}{\rho_+} \right) \right]$$

where b is the specific heat at constant volume. Combining with the general shock relations, we may put this in the form

$$S_- - S_+ = b \left[\ln \left(1 - \gamma \frac{1 - R}{1 + R} \right) - \ln \left(1 + \gamma \frac{1 - R}{1 + R} \right) - \gamma \ln R \right] \quad (26)$$

If $R = 1$ (no density change across the shock), then $S_- = S_+$. For R only slightly different from 1, then (26) may be expanded to give

$$S_- - S_+ \approx \frac{b\gamma(\gamma^2 - 1)}{12} (R - 1)^3 \quad (27)$$

where higher power terms in $(R - 1)$ have been dropped.

The Second Law of Thermodynamics states that entropy increases or is constant in any closed macroscopic system. Thus, when a shock is formed, R must be greater than 1. Furthermore, for any shock, R must always be greater than 1 since, to change to $R < 1$, the region of validity of (27) must be approached. This means that shocks must always be compressive in the polytropic gas discussed here. A more general argument along similar lines can be used to prove that all shocks are compressive.

IV. SHOCKS

Hugoniot Relation

There are two extreme ways (with no heat flow) in which a fluid can be compressed monotonically: impulsively or very slowly. In the latter case, the fluid remains isentropic, and the adiabatic equation of state holds. Alternately, in the case of shocks, we have seen (16) that

$$I_- - I_+ = \frac{p_- + p_+}{2} \left(\frac{1}{\rho_+} - \frac{1}{\rho_-} \right)$$

This, together with the equation of state in the form $I = I(\rho, p)$, gives a relation, called the Hugoniot relation, between pressure and density for shock compression.

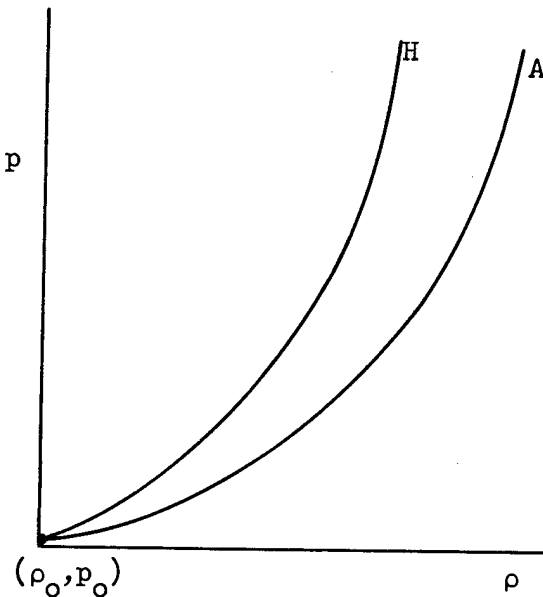

A plot of the adiabatic and Hugoniot pressure-density relations for a material shows that the "adiabat" lies below the "Hugoniot." This is because, in general, a shock compression increases the internal energy more than an adiabatic compression, and further, for a fixed compression, pressure increases with internal energy.

For any monotonic compression of a fluid, its state will always be such that its pressure and density determine a point which lies between

HUGONIOT RELATION

the A and H curves. / Any subsequent expansion of an element of the fluid will be adiabatic. In general, the slope of the adiabat at any point is less than the slope of the Hugoniot. As a result, it is impossible, in the absence of heat flow, for a fluid to be changed in such a way that its (ρ, p) point will lie directly to the right of any point where it has previously been. This irreversible trend of migration of (ρ, p) points to the left is identically equivalent to the trend of irreversibly increasing entropy.

CHAPTER V

DIMENSIONALITY AND SIMILARITY

Scaling

Consider the problem of determining the flow field about an airplane. We assume for now that the air can be treated as a simple gas (i.e., the effects of viscosity and heat conduction can be neglected.) Even so, the analytical calculation would be extremely difficult, and an experimental approach is required. A model is built and tested in a wind tunnel. The question then arises: What bearing do the test results have on the nature of flow around the real airplane? Another question of interest is: Can the results of a test at the extreme of wind-tunnel capabilities be extended to give information in the region beyond those capabilities? Considerable effort has been expended to answer these questions, and much of many aerodynamic textbooks is devoted to related discussions. We shall discuss the matter only slightly.

Consider the Eulerian equations in the form

$$\rho \frac{\partial \mathbf{u}}{\partial t} + \rho(\vec{\mathbf{u}} \cdot \nabla)\vec{\mathbf{u}} = - \nabla p$$

$$\frac{\partial \rho}{\partial t} + \nabla \cdot (\rho \vec{\mathbf{u}}) = 0$$

SCALING

$$\rho \frac{\partial \mathbf{I}}{\partial t} + \rho (\vec{u} \cdot \nabla) \mathbf{I} = - p \nabla \cdot \vec{u}$$

Now let the entire system be rescaled such that

$$\rho \rightarrow \rho_o \rho$$

$$p \rightarrow p_o p$$

$$\mathbf{I} \rightarrow \mathbf{I}_o \mathbf{I}$$

$$\vec{u} \rightarrow u_o \vec{u}$$

$$t \rightarrow t_o t$$

$$\vec{r} \rightarrow x_o \vec{r}$$

where the subscript o here indicates a constant, dimensionless scaling factor. Then the equations become

$$\left(\frac{\rho_o u_o}{t_o} \right) \rho \frac{\partial \vec{u}}{\partial t} + \left(\frac{\rho_o u_o^2}{x_o} \right) (\vec{u} \cdot \nabla) \vec{u} = - \left(\frac{p_o}{x_o} \right) \nabla p$$

$$\left(\frac{\rho_o}{t_o} \right) \frac{\partial \rho}{\partial t} + \left(\frac{\rho_o u_o}{x_o} \right) \nabla \cdot (\rho \vec{u}) = 0$$

$$\left(\frac{\rho_o \mathbf{I}_o}{t_o} \right) \rho \frac{\partial \mathbf{I}}{\partial t} + \left(\frac{\rho_o u_o \mathbf{I}_o}{x_o} \right) \rho (\vec{u} \cdot \nabla) \mathbf{I} = - \left(\frac{\rho_o u_o}{x_o} \right) p \nabla \cdot \vec{u}$$

These equations will be identically the same as the original ones, provided that

$$\frac{p_o}{\rho_o u_o^2} = \frac{x_o}{u_o t_o} = \frac{\mathbf{I}_o}{u_o^2} = 1$$

V. DIMENSIONALITY AND SIMILARITY

In addition, the sound speed is defined by $c^2 = (\partial p / \partial \rho)_s$ so that, with $c \rightarrow c_0 c$, we also have

$$\frac{p_0}{\rho_0 c_0^2} = 1$$

and the scaling laws can be rewritten

$$u_0^2 = I_0 = \frac{p_0}{\rho_0} = \frac{x_0^2}{t_0^2} = c_0^2 \quad (1)$$

Thus, in the case of the airplane and its model, results of tests can be applied to the full scale provided that the ratio of flow speed to sound speed is the same in both cases. This important ratio is called the Mach number of the flow. The requirements $I_0 = p_0 / \rho_0 = c_0^2$ are certainly satisfied for a polytropic gas. The relation $x_0 / t_0 = c_0$ gives the time scale for occurrences in terms of the scaling of linear dimensions. Thus, if the sound speed is the same for the airplane and its model and if the airplane is, say, 5 times as long, then it takes 5 times as much time for a similar change in flow pattern to take place.

When the gas is viscous and conducting of heat, additional parameters result from scaling arguments. These are discussed in Chapter VIII.

Similarity

In some cases of interest, a flow field may retain geometric similarity to itself as it develops in time. This is the case in one dimension, for instance, if all features of the flow field are functions of x/t alone. The example of piston withdrawal in Chapter III [see (III-13)] is an illustration.

SIMILARITY

Consider the one-dimensional equations in the form

$$\rho \frac{\partial u}{\partial t} + \rho u \frac{\partial u}{\partial x} = - \frac{\partial p}{\partial x}$$

$$\frac{\partial \rho}{\partial t} + \rho \frac{\partial u}{\partial x} + u \frac{\partial \rho}{\partial x} = 0$$

$$\frac{\partial A}{\partial t} + u \frac{\partial A}{\partial x} = 0$$

where A is any function of entropy alone; for a polytropic gas, we take

$$A = \frac{p}{\rho^\gamma}$$

We now assume that there exists a function $y(x,t)$ such that ρ , u , and p are functions of y only. Then

$$\frac{\partial u}{\partial t} = u' \frac{\partial y}{\partial t}$$

$$\frac{\partial u}{\partial x} = u' \frac{\partial y}{\partial x}$$

and similarly for p and ρ . Here a prime denotes differentiation with respect to y . Note that this is really a part of the more general transformation

$$y = y(x,t)$$

$$z = t$$

after which we assume independence from z , so that all features of the

V. DIMENSIONALITY AND SIMILARITY

flow field are independent of time in the transformed coordinate system. Note that the transformed coordinate system moves with respect to the original one with a velocity

$$v = - \frac{(\partial y / \partial t)}{(\partial y / \partial x)} \quad (2)$$

Putting these assumptions into the original equations, we get expressions which reduce to

$$\begin{aligned} \rho u'(u - v) &= - p' \\ \rho' (u - v) &= - \rho u' \\ A' (u - v) &= 0 \end{aligned} \quad (3)$$

Thus, to be consistent with the original assumptions, v must be a function of y only. This is equivalent to the condition

$$y = f[x - v(y)t] \quad (4)$$

where f is an arbitrary function of its argument. Thus, in this generalized similarity transformation, f and v can be chosen as arbitrary functions and the equation for $y(x,t)$ can be obtained.

The special case in which $v \equiv u$ is trivial. It is an equilibrium solution in which all characteristics of an element of fluid are constant. It can be written in the form

$$A(y) \equiv \text{arbitrary function}$$

$$u(y) \equiv \text{constant}$$

$$p(y) \equiv \text{constant}$$

$$\rho(y) \equiv \text{arbitrary function}$$

and $I(y)$ is related to $\rho(y)$ in such a way that the pressure is everywhere the same.

If $v \neq u$, then

$$A \equiv \text{constant}$$

$$(\rho u')^2 = \rho' p'$$

Thus p is a function of ρ only, and we may use the definition (III-2)

$$d\sigma = \frac{cd\rho}{\rho}$$

to obtain

$$du = \pm d\sigma$$

or

$$u = u_0 \pm \sigma \tag{5}$$

where u_0 is a fixed constant. Note that this is the same result as obtained from the theory of characteristics except that now there is not yet any specification of the path along which $u \pm \sigma$ is constant. We put (5) into (3) to obtain

$$\pm \rho \sigma' (u_0 \pm \sigma - v) = -c\rho \sigma'$$

The case $\sigma' = 0$ is again trivial; in order that $\sigma' \neq 0$, it is necessary that

$$u_0 \pm \sigma - v \pm c = 0$$

or

$$v = u \pm c$$

V. DIMENSIONALITY AND SIMILARITY

Thus the transformed coordinate system must everywhere move with the velocity of the characteristic lines.

The problem of the constant-speed retracting piston of Chapter III is now solved with ease. Put $v = \alpha(x/t)$ (where $\alpha = \text{constant}$) and, for a polytropic gas, $\sigma = 2c/(\gamma - 1)$. Then

$$\alpha \frac{x}{t} = u \pm c$$

$$u = u_0 \pm \frac{2c}{\gamma - 1}$$

Application of appropriate boundary conditions then yields the solution.

Various other types of similarity solutions are applicable to special cases. Sometimes considerable ingenuity is required to find one which satisfies the desired initial and boundary conditions. In many cases, no such solution has yet been found. Chapter VI shows the application of another type of similarity assumption to the problem of a decaying shock.

CHAPTER VI

DECAY OF A SHOCK PULSE

General Discussion

We have seen in previous chapters how the compressive motion of a piston can produce a shock. In most practical situations, however, the piston pushes for only a finite time. When it stops, the fluid at first continues to rush away and a rarefaction is formed. In general, the rarefaction will overtake the shock and modify it; the shock will decay. The sequence is shown qualitatively in the following successive plots of pressure as a function of distance.

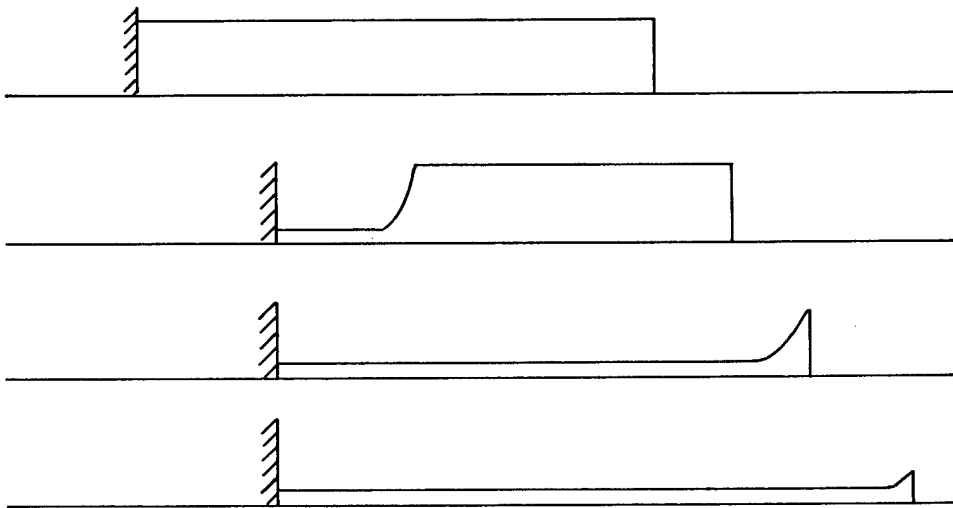

VI. DECAY OF A SHOCK PULSE

Most problems concerning shock decay are very difficult to solve. We shall consider two special cases. In the first one, the shock is formed by the very short impulsive motion of a piston adjacent to a cold polytropic gas. In the second one, a weak shock decays under the action of an overtaking simple rarefaction.

Decay of a Very Strong, Impulsively-Formed Shock Pulse

In this section we discuss a special case of a more general result as summarized from the Russian literature by Hayes and Probstein.* Their calculations were performed in Eulerian coordinates; we have used Lagrangian coordinates and, in addition, have tried to show how the various similarity assumptions arise from one basic, initial assumption.

Because we shall refer to both Eulerian and Lagrangian coordinates, we shall carefully keep track of them by the designations x and x_0 , respectively (at $t = 0$, $x \equiv x_0$). The problem is described as follows. Before $t = 0$, the polytropic gas is cold and at rest (thus it has zero sound speed). At $t = 0$, an instantaneous impulse is applied by a piston at $x = 0$; thereafter the piston remains fixed at $x = 0$ so that the amounts of energy and mass in the region for $x \geq 0$ remain constant. A shock propagates away from the piston; its position is x_s which is a function of time, and its velocity is

$$v \equiv \frac{dx_s}{dt}$$

* W. D. Hayes and R. F. Probstein, "Hypersonic Flow Theory," Academic Press, Inc., New York, 1959, pp. 52 ff.

DECAY OF A VERY STRONG, IMPULSIVELY-FORMED SHOCK PULSE

The boundary conditions at the shock are

$$\rho_s = \frac{\gamma + 1}{\gamma - 1} \rho_0$$

$$u_s = \frac{2}{\gamma + 1} v$$

$$p_s = \frac{2}{\gamma + 1} \rho_0 v^2$$

Thus, the density is forever constant at the shock, while the pressure and material speed vary with the shock speed.

We work with the Lagrangian equations of motion

$$\rho_0 \frac{\partial u}{\partial t} = - \frac{\partial p}{\partial x_0}$$

$$\frac{\partial \rho}{\partial t} = - \frac{\rho^2}{\rho_0} \frac{\partial u}{\partial x_0}$$

$$\frac{\partial}{\partial t} \left(\frac{p}{\rho} \right) = 0$$

The basic assumption, which will be given a posteriori justification, is that there is a generalized similarity solution in which the density is a function of x_0/x_s only. That is,

$$\rho(x_0, t) = \rho_s f(y) \tag{1}$$

where

$$y \equiv \frac{x_0}{x_s} \tag{2}$$

From this assumption only, there result the other features of the

VI. DECAY OF A SHOCK PULSE

similarity solution; they are consequences, not additional assumptions.

The boundary condition on $f(y)$ is that $f(1) = 1$.

Now

$$\frac{\partial y}{\partial t} = - \frac{x_0}{x_s^2} \frac{dx_s}{dt} = - \frac{vx_0}{x_s^2}$$

$$\frac{\partial y}{\partial x_0} = \frac{1}{x_s}$$

Thus

$$\frac{\partial \rho}{\partial t} = - \frac{vx_0 \rho_s}{x_s^2} f'$$

$$\frac{\partial \rho}{\partial x} = \frac{\rho_s}{x_s} f'$$

where the prime denotes differentiation with respect to y . We may now consider $u(x_0, t)$ to be, instead, a function of y and t . Then

$$\frac{\partial u}{\partial x_0} = \frac{1}{x_s} \frac{\partial u}{\partial y}$$

and the mass equation becomes

$$vyf' = \frac{\rho_s}{\rho_0} f^2 \frac{\partial u}{\partial y}$$

Thus it is necessary that the dependence of $u(y, t)$ on time must come in having u directly proportional to v . We write

$$u = \frac{2}{\gamma + 1} vg(y)$$

DECAY OF A VERY STRONG, IMPULSIVELY-FORMED SHOCK PULSE

so that $g(1) = 1$, and the mass equation becomes

$$yf' = \frac{2}{\gamma - 1} f^2 g' \quad (3)$$

Next, consider the momentum equation. By a similar process, it becomes

$$\frac{2}{\gamma + 1} \rho_0 \left(x_s \frac{dv}{dt} g - v^2 y g' \right) = - \frac{\partial p}{\partial y}$$

Thus, p , considered as a function of y and t , must be written in the form

$$p(y,t) = x_s \frac{dv}{dt} (\text{function of } y) + v^2 (\text{function of } y)$$

But

$$p(1,t) \equiv \frac{2}{\gamma + 1} \rho_0 v^2$$

Thus $x_s (dv/dt)$ must be identically proportional to v^2 , and it follows that we can write

$$x_s = Kt^n \quad (4)$$

where K and n are arbitrary constants. (This comes from integrating the equation

$$x_s \frac{d^2 x_s}{dt^2} = \frac{n-1}{n} \left(\frac{dx_s}{dt} \right)^2$$

and applying the boundary condition that at $t = 0$, $x_s = 0$.) Thus, we put

$$p = \frac{2}{\gamma + 1} \rho_0 v^2 h(y)$$

VI. DECAY OF A SHOCK PULSE

so that $h(1) = 1$. As a result, the momentum equation has become

$$h' = yg' + \frac{1-n}{n} g \quad (5)$$

Finally, there is the entropy equation which states that

$$\frac{\partial}{\partial t} \left(\frac{p}{\rho^\gamma} \right) = 0$$

Thus the quantity

$$\frac{v^2 h(y)}{f^\gamma(y)}$$

must be independent of time. Because v^2 is proportional to t^{2n-2} , we see that

$$\frac{h}{f^\gamma} \sim y^{(2n-2)/n}$$

Since $h(1) = f(1) = 1$, the constant of proportionality is 1, and

$$h = f^\gamma y^{(2n-2)/n} \quad (6)$$

The over-all conservation laws give further information concerning the problem. Thus, for over-all conservation of mass, we require

$$\int_0^{x_s} \rho dx = \rho_0 x_s$$

This, however, is satisfied identically, since

$$\int_0^{x_s} \rho dx \equiv \int_0^{x_s} \rho_0 dx_0$$

DECAY OF A VERY STRONG, IMPULSIVELY-FORMED SHOCK PULSE

The momentum equation gives more valuable results. We require

$$\frac{d}{dt} \int_0^{x_s} \rho u \, dx = p(0)$$

where $p(0)$ is the pressure at the point $x = 0$, that is, at the piston.

Then

$$\frac{d}{dt} \int_0^{x_s} u \, dx = \frac{p(0)}{\rho_0}$$

or

$$\frac{2n-1}{n} \int_0^1 g \, dy = h(0) \quad (7)$$

From this, we may distinguish several classes of solutions. If $n = 1/2$, then $h(0) = 0$. If $n \neq 1/2$, then $h(0) \neq 0$, or else if $h(0) = 0$, then g must change sign in the interval or identically vanish. We shall see below that $n = 2/3$ and thus conclude that $h(0) \neq 0$ is required.

The energy conservation equation states that

$$\int_0^{x_s} \left(\frac{p}{\gamma-1} + \frac{1}{2} \rho u^2 \right) dx = E_T$$

where E_T is the constant total energy of the system. This can be put into the form

$$\int_0^1 \left(\frac{h}{f} + g^2 \right) dy = \frac{(\gamma+1)^2 E_T}{2x_s v^2 \rho_0} \quad (8)$$

Thus $x_s v^2$ must be constant in time. Since

VI. DECAY OF A SHOCK PULSE

$$x_s v^2 \equiv K^3 n^2 t^{3n-2}$$

it follows that $n = 2/3$.

In summary, with $n = 2/3$, we now have the three equations

$$\left. \begin{aligned} h' &= yg' + \frac{1}{2} g \\ yf' &= \frac{2}{\gamma - 1} f^2 g' \\ yh &= f^\gamma \end{aligned} \right\} \quad (9)$$

together with the conditions $h(1) = f(1) = g(1) = 1$, and the expectation that $h(0) \neq 0$, $g(0) = 0$, and that in the interval $0 \leq y \leq 1$ the dependent variables are all positive. If these conditions can be fulfilled, then the similarity assumption may be reasonable. It may be noted that $f(0) = 0$, so that the temperature at the origin must be infinite in order that the pressure not vanish. This, then, adds another physical condition to the limit of applicability.

Once a solution has been obtained, then the energy integral can be evaluated and K determined as a function of E_T

$$\int_0^1 \left(\frac{h}{f} + g^2 \right) dy = \frac{9(\gamma + 1)^2 E_T}{8K^3 \rho_0} \quad (10)$$

The left side is a function of γ only, so that

$$K = \left(\frac{E_T}{\rho_0} \right)^{1/3} \quad (\text{function of } \gamma) \quad (11)$$

One useful relationship which may be obtained without a complete

DECAY OF A VERY STRONG, IMPULSIVELY-FORMED SHOCK PULSE

solution is that between the Eulerian and Lagrangian position variables.

We use the relation

$$\rho dx = \rho_0 dx_0$$

from which

$$\begin{aligned} dx &= \frac{\rho_0 dx_0}{\rho_s f\left(\frac{x_0}{x_s}\right)} \\ &= \left(\frac{\gamma - 1}{\gamma + 1}\right) \left(\frac{x_s dy}{f(y)}\right) \\ x &= \frac{\gamma - 1}{\gamma + 1} x_s \int_0^y \frac{dy}{f(y)} \end{aligned}$$

Now

$$\frac{yf'}{f^2} = \frac{2g'}{\gamma - 1}$$

so that

$$\int_0^y \frac{yf'}{f^2} dy = \frac{2g(y)}{\gamma - 1}$$

Integrate this by parts and combine with the equation for x to obtain

$$x = \frac{\gamma - 1}{\gamma + 1} x_s \left[\frac{2g(y)}{\gamma - 1} + \frac{y}{f(y)} \right] \quad (12)$$

This shows that x/x_s is a function of x_0/x_s only, so that $h(y)$, $f(y)$, and $g(y)$ could just as well have been written as functions of x/x_s .

If the solution is obtained in one coordinate system, it can thus be transformed to the other.

VI. DECAY OF A SHOCK PULSE

The process of solving the equations can be simplified by using the fact that there must be no energy flux across any similarity line.

Thus

$$\left(\frac{p}{\gamma - 1} + \frac{1}{2} \rho u^2\right) (u - u_{\text{sim}}) + pu \equiv 0 \quad (13)$$

where u_{sim} is the velocity of a similarity line at fixed y . From the relationship between Eulerian and Lagrangian coordinates, we may see that

$$u_{\text{sim}} = \frac{\gamma - 1}{\gamma + 1} v \left(\frac{2g}{\gamma - 1} + \frac{y}{f} \right)$$

so that the desired relation is

$$(h + fg^2)y = 2hgf \quad (14)$$

This may be used in place of any of the differential relations.

Hayes and Probstein display the complicated solution to the problem and show graphs of the results (as a function of the Eulerian similarity variable) for $\gamma = 1.4$. We here derive instead a simple approximate solution which shows the qualitative features and which satisfies the boundary conditions. We start by trying as a solution

$$h(y) = h(0) + \lambda y^n$$

$$g(y) = y^m$$

where m and n are to be determined. To satisfy $h(1) = 1$, $\lambda = 1 - h(0)$.

DECAY OF A VERY STRONG, IMPULSIVELY-FORMED SHOCK PULSE

These satisfy the equation which does not contain f provided that

$$n = \frac{1}{2(1 - \lambda)}$$

$$m = \frac{2\lambda - 1}{2(1 - \lambda)}$$

The equation between g and f can also be satisfied provided that

$$f = \frac{y^{1-m}}{y^{1-m} + \frac{2m}{(\gamma - 1)(1 - m)}(1 - y^{1-m})}$$

Finally, however, there is a relation between h and f which cannot be satisfied, even to lowest order in y unless $\gamma = 1$ (in which case it can be satisfied identically). In order that the lowest order exponents be the same, we choose $\gamma(1 - m) = 1$. As a result, there follows the approximate solution

$$\left. \begin{aligned} g(y) &= y^{(\gamma-1)/\gamma} \\ h(y) &= \frac{1}{2(2\gamma - 1)} \left[\gamma + (3\gamma - 2)y^{(2\gamma-1)/\gamma} \right] \\ f(y) &= \left[yh(y) \right]^{1/\gamma} \end{aligned} \right\} \quad (15)$$

This predicts that

$$h(0) = \frac{\gamma}{2(2\gamma - 1)} \quad (16)$$

which is surprisingly accurate. The exact result is

VI. DECAY OF A SHOCK PULSE

$$h(0) = \left(\frac{1}{2}\right)^{2/3} \cdot \left(\frac{\gamma+1}{2\gamma-1}\right)^{(5\gamma-4)/3(\gamma-2)} \quad (17)$$

γ	$h(0)$ exact	$h(0)$ approximate
1	0.5	0.5
2	0.3234	0.3333
∞	0.1984	0.25

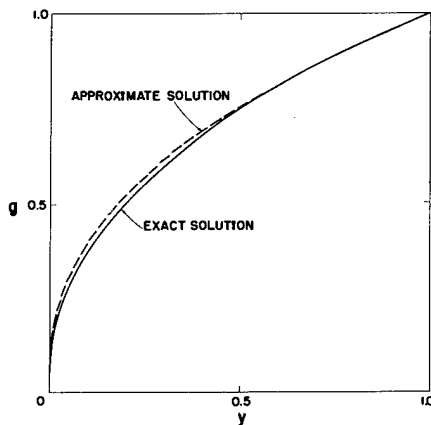

A comparison is shown of the approximate and exact solutions for $g(y)$ for the case $\gamma = 5/3$. For smaller values of γ , the agreement is even better, and in the limit $\gamma \rightarrow 1$ the approximate solution becomes exactly correct.

It is an important feature of the solution that the shock pressure decreases in proportion to $t^{-2/3}$ in this constant-energy case.

Interaction of a Rarefaction Overtaking a Weak Shock

Consider, first, a shock moving into a polytropic gas which is at rest but which has sound speed c_+ . We refer to equations (IV-17) and (IV-18), put into the form

$$\frac{u_-}{c_+} = \frac{2(M^2 - 1)}{(\gamma + 1)M}$$

INTERACTION OF A RAREFACTION OVERTAKING A WEAK SHOCK

$$\frac{c_-}{c_+} = \frac{1}{\gamma + 1} \sqrt{[\gamma - 1 + (2/M^2)] [2\gamma M^2 - \gamma + 1]}$$

We shall need these in the weak-shock limit; let $M \equiv 1 + \epsilon$, where $\epsilon \ll 1$; then

$$\left. \begin{aligned} \frac{u_-}{c_+} &\approx \frac{4\epsilon}{\gamma + 1} \\ \frac{c_-}{c_+} &\approx 1 + 2\epsilon \left(\frac{\gamma - 1}{\gamma + 1} \right) \end{aligned} \right\} \quad (18)$$

This shock is followed by a simple rarefaction which arises at $x = 0, t = 0$. Using the method of Chapter III, we find that the rarefaction can be characterized by

$$u = \frac{2}{\gamma + 1} \left(\frac{x}{t} \right) - K$$

$$c = \frac{\gamma - 1}{\gamma + 1} \left(\frac{x}{t} \right) + K$$

within the rarefaction region. The constant K is related to the shock conditions at the instant of collision by

$$K = \left(\frac{2c_-}{\gamma + 1} - \frac{\gamma - 1}{\gamma + 1} u_- \right)_{\text{at collision}}$$

The question now arises: Can the rarefaction solution be joined identically to that of the shock? In general, the answer is no. Only in the special case that the shock is weak can the joining be made:

$$\frac{2}{\gamma + 1} \left(\frac{x_s}{t} \right) - K \equiv c_+ \left(\frac{4\epsilon}{\gamma + 1} \right)$$

VI. DECAY OF A SHOCK PULSE

$$\frac{\gamma - 1}{\gamma + 1} \left(\frac{x_s}{t} \right) + K \equiv c_+ \left[1 + 2\epsilon \left(\frac{\gamma - 1}{\gamma + 1} \right) \right]$$

where x_s is the shock position. These two relations must be identically the same, if the joining is correct; with the general shock relations this cannot be accomplished; in this special case it can, as follows.

The two equations are written

$$\frac{x_s}{t} - 2\epsilon c_+ = \frac{\gamma + 1}{2} K$$

$$\frac{x_s}{t} - 2\epsilon c_+ = \frac{\gamma + 1}{\gamma - 1} (c_+ - K)$$

These are the same provided that

$$K = \frac{2c_+}{\gamma + 1}$$

In the weak-shock limit this requirement is satisfied. Thus the two equations become

$$\frac{x_s}{t} - 2\epsilon c_+ = c_+$$

Now $\epsilon \equiv M - 1$ so that $c_+ \epsilon \equiv v - c_+$. Also,

$$v \equiv \frac{dx_s}{dt}$$

so that

$$\frac{x_s}{t} - 2 \left(\frac{dx_s}{dt} - c_+ \right) = c_+$$

or

INTERACTION OF A RAREFACTION OVERTAKING A WEAK SHOCK

$$2 \frac{dx_s}{dt} - \frac{x_s}{t} = c_+$$

This has the solution

$$x_s = c_+ t + N\sqrt{t} \tag{19}$$

in which N is a constant. Thus, the shock speed asymptotically approaches sound speed ahead of it:

$$v = c_+ + \frac{N}{2\sqrt{t}} \tag{20}$$

Note that this solution predicts infinite shock speed at $t = 0$, in contradiction to the weak-shock assumption. Thus the solution is valid only for late times. Note also the prediction of shock-pressure decay as $t^{-1/2}$ compared to $t^{-2/3}$ in the preceding section.

CHAPTER VII

INVERTED HYDRODYNAMIC EQUATIONS

The Transformation

Even for a simple, isentropic gas, the hydrodynamic equations are difficult to handle in complete generality. The complications arise mainly from nonlinearity of the equations. One means of circumventing the difficulty is by the method discussed in this chapter (sometimes called the "speedgraph" method). The hodograph transformation for steady flow is part of a very similar method.

We start with the equations in the form used in Chapter III (see III-3); the gas is assumed to be simple and isentropic.

$$\left. \begin{aligned} \frac{\partial u}{\partial t} + u \frac{\partial u}{\partial x} + c \frac{\partial \sigma}{\partial x} &= 0 \\ \frac{\partial \sigma}{\partial t} + u \frac{\partial \sigma}{\partial x} + c \frac{\partial u}{\partial x} &= 0 \end{aligned} \right\} \quad (1)$$

To remove the nonlinearity these are transformed to a set of equations in which the dependent variables are x and t and the independent variables are u and σ ; the resulting equations are then linear and homogeneous, and thus amenable to treatment by more familiar methods.

We introduce the shorthand notation $x_\sigma \equiv (\partial x / \partial \sigma)_{u=\text{constant}}$, etc.,

THE TRANSFORMATION

in which partial derivatives of x or t with respect to u or σ are taken with consideration of x and t being functions of u and σ , and vice versa.

For example:

$$dx = x_{\sigma} d\sigma + x_u du$$

so that, with t held constant,

$$1 = x_{\sigma} \sigma_x + x_u u_x$$

or with x held constant,

$$0 = x_{\sigma} \sigma_t + x_u u_t$$

Two more independent relations of this kind can be derived; we write them in the form

$$0 = x_u \sigma_x + t_u \sigma_t$$

$$0 = u_t t_{\sigma} + u_x x_{\sigma}$$

These four relations can be solved for derivatives of u and σ :

$$\left. \begin{aligned} u_t &= + \frac{x_{\sigma}}{\text{Det}} \\ u_x &= - \frac{t_{\sigma}}{\text{Det}} \\ \sigma_t &= - \frac{x_u}{\text{Det}} \\ \sigma_x &= + \frac{t_u}{\text{Det}} \end{aligned} \right\} \quad (2)$$

where

VII. INVERTED HYDRODYNAMIC EQUATIONS

$$\text{Det} \equiv x_{\sigma} t_u - x_u t_{\sigma} \quad (3)$$

Validity of the transformation requires $\text{Det} \neq 0$.

With these transformation equations, the equations in (1) become

$$\frac{\partial x}{\partial \sigma} - u \frac{\partial t}{\partial \sigma} = -c \frac{\partial t}{\partial u} \quad (4)$$

$$\frac{\partial x}{\partial u} - u \frac{\partial t}{\partial u} = -c \frac{\partial t}{\partial \sigma} \quad (5)$$

Since c is a function of σ only, these equations are linear and homogeneous in their dependent variables. From these two equations, x can be eliminated

$$\frac{\partial^2 t}{\partial u^2} - \frac{\partial^2 t}{\partial \sigma^2} = \frac{1}{c} \left(1 + \frac{dc}{d\sigma} \right) \frac{\partial t}{\partial \sigma} \quad (6)$$

A similar equation for x can also be obtained, but it is not as concise. The amount of difficulty involved in solving (6) depends upon the nature of the function $(1/c)[1 + (dc/d\sigma)]$, which, in turn, depends upon the form of the equation of state. For a polytropic gas, for example,

$$\frac{\partial^2 t}{\partial u^2} - \frac{\partial^2 t}{\partial \sigma^2} = \left(\frac{\gamma + 1}{\gamma - 1} \right) \frac{1}{\sigma} \frac{\partial t}{\partial \sigma} \quad (7)$$

Even simpler is the equation resulting from the equation of state

$$p = \alpha - \frac{\beta}{\rho} \quad (8)$$

where α and β are constants. [Such an equation of state may be useful if a very small range of densities is involved; then (8) may fit the

true equation of state sufficiently well over the range of interest.]

The form of (6) with the relation (8) is

$$\frac{\partial^2 t}{\partial u^2} - \frac{\partial^2 t}{\partial \sigma^2} = 0$$

the simple wave equation, which has the general solution

$$t = l_1(u + \sigma) + l_2(u - \sigma)$$

where l_1 and l_2 are arbitrary functions of their arguments (arbitrary, that is, except for the restrictions imposed by continuity and nonvanishing of the transformation determinant). The corresponding solution for x is

$$x = \int^{\sigma+u} (\xi - K) l_1'(\xi) d\xi + \int^{u-\sigma} (\xi + K) l_2'(\xi) d\xi$$

where K and the lower limits of the integrations are arbitrary constants.

With this solution (3) becomes

$$\text{Det} = -4c l_1' l_2'$$

which must not vanish if the transformation is to be valid.

Returning to (7), we make the substitution

$$\gamma = \frac{2n + 1}{2n - 1}$$

Then, for integer $n > 0$, the most general solution is

$$t = \left(\frac{\partial}{\partial u} + \frac{\partial}{\partial \sigma} \right)^{n-1} \left[\frac{l_1(u + \sigma)}{\sigma^n} \right] + \left(\frac{\partial}{\partial u} - \frac{\partial}{\partial \sigma} \right)^{n-1} \left[\frac{l_2(u - \sigma)}{\sigma^n} \right] \quad (9)$$

VII. INVERTED HYDRODYNAMIC EQUATIONS

where l_1 and l_2 are arbitrary functions of their arguments. The special cases of a monatomic gas ($\gamma = 5/3$, $n = 2$) and a diatomic gas ($\gamma = 7/3$, $n = 3$) are covered by this solution. The fictitious case, $\gamma = 3$ ($n = 1$) has a particularly simple solution

$$t = \frac{1}{\sigma} [l_1(u + \sigma) + l_2(u - \sigma)] \quad (10)$$

In this special case, $c \equiv \sigma$.

The solution for x follows from (4) and (5), either directly or through the following transformation:

$$y \equiv x - ut$$

$$z \equiv \sigma t$$

Then, for a polytropic gas,

$$\frac{\partial y}{\partial \sigma} = - \frac{\gamma - 1}{2} \frac{\partial z}{\partial u}$$

$$\frac{\partial y}{\partial u} = - \frac{\gamma - 1}{2} \frac{\partial z}{\partial \sigma} + \frac{z}{\sigma} \left(\frac{\gamma - 3}{2} \right)$$

For $\gamma = 3$, these become particularly simple, and the solution is (10) together with

$$y = -l_1(u + \sigma) + l_2(u - \sigma)$$

or

$$x = ut - l_1(u + \sigma) + l_2(u - \sigma) \quad (11)$$

A useful form of these general solutions, which follows directly from (10) and (11), is

EXAMPLE: EXPANSION INTO A VACUUM

$$u + \sigma = F[x - (u + \sigma)t] \quad (12)$$

$$u - \sigma = G[x - (u - \sigma)t] \quad (13)$$

Here F and G are arbitrary functions of their arguments. [It should be noted that (12) and (13) can be derived simply and directly from the original equations as a direct consequence of the fact that for $\gamma = 3$, σ and c are identically equal.* A directly analogous derivation for any other value of γ is not possible.]

Example: Expansion into a Vacuum

Initially the gas is at rest; for $x < 0$, there is vacuum, for $x \geq 0$ there is gas. Define

$$H(x) \equiv \left. \begin{array}{ll} 0 & x < 0 \\ 1 & x > 0 \end{array} \right\} \quad (14)$$

$$0 \leq H(x) \leq 1 \quad x = 0$$

and let α be a fixed constant. Then, at $t = 0$,

$$\left. \begin{array}{l} \sigma = \alpha H(x) \\ u = \alpha[H(x) - 1] \end{array} \right\} \quad (15)$$

The form of u follows from the fact that the motion is that of a simple wave in which $u - \sigma$ has everywhere the same value. Combining with the

* For $\gamma = 3$, the one-dimensional Eulerian equations are

$$\frac{\partial u}{\partial t} + u \frac{\partial u}{\partial x} = -\sigma \frac{\partial \sigma}{\partial x}, \quad \frac{\partial \sigma}{\partial t} + u \frac{\partial \sigma}{\partial x} = -\sigma \frac{\partial u}{\partial x}, \quad \text{or} \quad \frac{\partial}{\partial t} (u \pm \sigma) + (u \pm \sigma) \frac{\partial}{\partial x} (u \pm \sigma) = 0.$$

The general solution of this pair is seen to be $u \pm \sigma = F_{\pm}[x - (u \pm \sigma)t]$.

VII. INVERTED HYDRODYNAMIC EQUATIONS

solution (12) and (13), we get

$$u + \sigma = \alpha \left\{ 2H[x - (u + \sigma)t] - 1 \right\}$$

$$u - \sigma = -\alpha$$

or

$$u + \sigma > \frac{x}{t} \quad \text{for } u + \sigma = -\alpha$$

$$u + \sigma < \frac{x}{t} \quad \text{for } u + \sigma = \alpha$$

$$u + \sigma = \frac{x}{t} \quad \text{for } -\alpha \leq u + \sigma \leq \alpha$$

which seems like a strange way to express the solution, but this can be transformed to the equivalent, more familiar form

$$\left. \begin{aligned} u &= \frac{1}{2} \left(\frac{x}{t} - \alpha \right) \\ \sigma &= \frac{1}{2} \left(\frac{x}{t} + \alpha \right) \end{aligned} \right\} \text{ for } -\alpha \leq \frac{x}{t} \leq \alpha$$

for the region of the rarefaction wave. In particular, at $x/t = -\alpha$, $u = -\alpha$, the "escape speed."

It is also strange that the final solution depends upon the nature of the velocity profile in the vacuum (15). Had we taken $u \equiv 0$ at $t = 0$, the final result would have been meaningless.

Considerable additional discussion of this method has been given by R. von Mises^{*}, by Courant and Friedrichs,^{**} and by Landau and Lifshitz.^{***}

^{*}R. von Mises, "Mathematical Theory of Compressible Fluid Flow," Academic Press, Inc., New York, 1958.

^{**}Richard Courant and K. O. Friedrichs, "Supersonic Flow and Shock Waves," Interscience Publishing Company, New York, 1948, pp. 88-91; pp. 191-197.

^{***}L. D. Landau and E. M. Lifshitz, "Fluid Mechanics" Pergamon Press Ltd., London; Addison-Wesley Publishing Company, Inc., Reading, Mass., 1959, pp. 386-392.

CHAPTER VIII

THEORY OF VISCOSITY

General Description

Viscosity in fluids may arise from two main sources which are quite different but may be approximated by the same mathematical form:

1. Fluids which are "thick" and "sticky" derive their viscosity from their strong cohesion, or intermolecular attraction. Shear motion is accomplished by doing work to break these attractive bonds. Re-forming of the bonds leaves the molecules vibrationally excited, equivalent to conversion of energy to heat. The greater the heating, the more easily the bonds are broken, so that such viscosity decreases with temperature.

2. In gases, the intermolecular forces are of short range compared to separation, and the individual molecules move with much greater velocities than the local average of many of them (this average being the "local fluid velocity"). The molecules diffuse about among each other (in violation of our early assumption that elements remain adjacent). Thus, for example, a boundary between helium and hydrogen which is initially sharp will gradually be replaced by a widening zone of mixture. Likewise, the boundary between a cold region (average particle speed small) and a hot

VIII. THEORY OF VISCOSITY

one (average particle speed large) will be replaced by a widening warm zone as the fast moving molecules diffuse into the slower ones. In like manner, if there is a slip plane in the gas (that is, a discontinuity in mean molecular velocity), then the effect of diffusion will produce an apparent drag. This is because the molecules moving each way across the slip plane carry, on the average, the mean velocity of the side of origin, and mix this, through collisions, with the mean velocity from the other side. This is gaseous viscosity. Since the random molecular velocities (and thus the diffusion rates) increase with temperature, the viscosity and heat conduction will increase with temperature for this type of process.

The two viscosities are thus considerably different in their dependence on temperature. They also differ in that heat conduction is directly associated with the second type but arises (if even significant) from quite different processes in the first.

The usual concept of viscosity is that it produces a drag along a shear plane, but it is easily seen for the gaseous type how viscosity can affect one-dimensional motion. If there is a velocity gradient parallel to the velocity, then molecular diffusion can tend to decrease the gradient in just the same way as when the gradient is perpendicular to the velocity. The fact that the velocity vector can diffuse both parallel and perpendicular to itself leads us to suspect that a precise mathematical formulation will involve the use of tensors.

FORMULATION FROM THE DIFFUSION VIEWPOINT

Formulation from the Diffusion Viewpoint

To accomplish the formulation for gaseous viscosity, we consider first the momentum equation in conservative form. In true one-dimensional motion, the equation is (I-24)

$$\frac{\partial \rho u}{\partial t} + \frac{\partial}{\partial x} (\rho u^2 + p) = 0$$

The term in parentheses is the momentum flux past a point fixed in space; the first part is the transport due to fluid motion, the second is that produced by inter-element forces. If there is a gradient in fluid velocity (i.e., in mean local molecular velocity), then we expect an additional flux term, F , which depends upon the size of the gradient. We expand the flux in a Maclaurin series:

$$F = F\left(\frac{\partial u}{\partial x}\right) = F(0) + \frac{\partial u}{\partial x} F'(0) + \dots$$

The flux depends also upon such quantities as temperature (and so therefore do the expansion coefficients). There certainly will be no viscous flux if $\partial u / \partial x = 0$; also, for many situations only the lowest contributing terms in the expansion are required. Thus, we write

$$F = -\mu_0 \frac{\partial u}{\partial x}$$

and the momentum equation becomes

$$\frac{\partial \rho u}{\partial t} + \frac{\partial}{\partial x} (\rho u^2 + p - \mu_0 \frac{\partial u}{\partial x}) = 0 \quad (1)$$

The coefficient of viscosity is μ_0 . Note that the viscous term can be

VIII. THEORY OF VISCOSITY

considered a pressure modification.

In three dimensions, the momentum equation is (I-5)

$$\frac{\partial \rho \vec{u}}{\partial t} + \nabla \cdot (\rho \vec{u} \vec{u}) + \nabla p = 0$$

To avoid the awkward double vector, this is written in index notation

$$\frac{\partial \rho u_i}{\partial t} + \frac{\partial}{\partial x_j} (\rho u_i u_j) + \frac{\partial p}{\partial x_i} = 0 \quad (2)$$

The summation convention is here employed; any term in which an index appears twice is to be summed over that index:

$$\frac{\partial}{\partial x_j} (\rho u_i u_j) \quad \text{means} \quad \sum_{j=1}^3 \frac{\partial}{\partial x_j} (\rho u_i u_j)$$

The three components are Cartesian, but our final results can be transformed to any desired coordinate system. It is convenient to introduce the symbol δ_{ij} defined by $\delta_{ij} = 0$ for $i \neq j$; $\delta_{ij} = 1$ for $i = j$. Then (2) can be put into the form

$$\frac{\partial \rho u_i}{\partial t} + \frac{\partial}{\partial x_j} [\rho u_i u_j + p \delta_{ij}] = 0 \quad (3)$$

The bracket term is again a flux of momentum. The first part, arising from fluid transport past the reference point, signifies the rate of transport of j -direction momentum in the i direction. Likewise, the viscous flux, F_{ij} , must be a tensor whose components denote the rate of diffusion of j -component momentum in direction i .

The flux tensor must be symmetric. This can be demonstrated by

FORMULATION FROM THE DIFFUSION VIEWPOINT

the following simple example. Consider a small cube of fluid with sides parallel to the coordinate axes. Then F_{xy} is the x-direction momentum per unit area per unit time which enters the face normal to the y axis closest to the origin. This contributes to the cube a rate of increase of z-directed angular momentum about the cube center of $(s^2 F_{xy})(s/2)$ where s is the cube-side length. Through the other face normal to the y axis there likewise escapes x-direction momentum at the rate per unit area F_{xy} , and this likewise adds angular momentum in the same direction as that through the other face, the total angular momentum per unit time passing through the y-direction faces thus being $s^3 F_{xy}$. In similar manner, the angular momentum rate in this same angular direction passing through the x-direction faces is $-s^3 F_{yx}$. Now the moment of inertia of the cube is $1/6 (\rho s^3) s^2$ so that the rate of change of the angular velocity ω is given by

$$\frac{1}{6} \rho s^5 \dot{\omega} = s^3 (F_{xy} - F_{yx})$$

Since $\dot{\omega}$ must remain finite as $s \rightarrow 0$, it follows that $F_{xy} \equiv F_{yx}$. The same can be demonstrated in like manner for the other component pairs.

The viscous flux of momentum is again expected to vanish when there are no velocity gradients; we keep only first order terms in the expansion in powers of the gradients. Further F_{ij} must depend only upon symmetric combinations of these gradients. These symmetric combinations (called the "rates of strain") are

$$e_{ij} \equiv \frac{\partial u_i}{\partial x_j} + \frac{\partial u_j}{\partial x_i} \quad (4)$$

VIII. THEORY OF VISCOSITY

Besides being symmetric, the form of F_{ij} is further restricted by the requirement that the equations must have the same form no matter what may be the assignment of x , y and z to i and j . (More precisely, the viscous flux must be a tensor.) As a result, F_{ij} must be related to e_{ij} by a scalar function of proportionality. In addition, it may also be related to δ_{ij} by a scalar function of proportionality provided one can be found which vanishes with the rates of strain. Such can be found to be e_{kk} and, in conventional nomenclature, we finally write the flux tensor

$$F_{ij} = -\frac{1}{2} \lambda e_{kk} \delta_{ij} - \mu e_{ij} \quad (5)$$

Here μ and λ are scalar functions of position, termed, respectively, the first and second coefficients of viscosity.* The generalized momentum equation has thus become

$$\frac{\partial \rho u_i}{\partial t} + \frac{\partial}{\partial x_j} [\rho u_i u_j + (p - \frac{1}{2} \lambda e_{kk}) \delta_{ij} - \mu e_{ij}] = 0 \quad (6)$$

Notice with regard to scaling of this equation that if two flows are to be related by scaling, then λ and μ must be proportionally changed, and the "Reynolds number" scaling factor $(\rho_0 u_0 x_0) / \mu_0$ must be unity (i.e., the Reynolds number, $R_e = \rho u x / \mu$, must be the same). These conditions are in addition to those of Chapter V.

From a mathematical point of view, the combined effect of the

*See, however, W. H. Liepmann and A. Roshko, "Elements of Gasdynamics," John Wiley and Sons, Inc., New York, p. 337 in which $3\lambda + 2\mu$ is termed the second coefficient of viscosity. The reason for this choice is that in many common situations $3\lambda + 2\mu \equiv 0$.

FORMULATION FROM THE DIFFUSION VIEWPOINT

scalar pressure and the diffusion flux tensor is the same as that of a generalized stress tensor .

$$p_{ij} = - \left(p - \frac{1}{2} \lambda e_{kk} \right) \delta_{ij} + \mu e_{ij} \quad (7)$$

which is interpreted as composed of the components of normal and tangential force per unit area on Cartesian planes within the fluid. The interpretation is clearly artificial, but nevertheless useful. Most discussions of viscosity use this stress-tensor concept almost exclusively, obscuring the true origin of viscosity.

The negative average of the three normal pressures at a point is called the total pressure, p_T :

$$p_T \equiv - \frac{1}{3} p_{ii} = p - \left(\lambda + \frac{2}{3} \mu \right) \frac{\partial u_i}{\partial x_i} \quad (8)$$

The conservation of mass equation, which is not affected by the generalizations of this chapter, states that $\partial u_i / \partial x_i = - (1/\rho) (d\rho/dt)$, so that the contribution to total pressure due to the fluid motion is proportional to the compression rate of the fluid. It has been argued that this additional pressure is fictitious and should not be present, so that $\gamma + 2/3 \mu \equiv 0$. Many authors have treated flow problems using this assumption, but we shall keep the two coefficients independent in the discussions that follow. The second term in (8) is called the "dilatation pressure."

Note that for an incompressible fluid (for which $\nabla \cdot \vec{u} \equiv 0$) "second viscosity" plays no role, since the coefficient of λ vanishes identically.

VIII. THEORY OF VISCOSITY

From (6) many specialized forms may be derived which are useful. Some of these are discussed in Chapter IX, in examples of simple viscous flows. Equation (6) in full generality can be transformed to vector notation

$$\rho \frac{d\vec{u}}{dt} = \rho \vec{g} - \nabla p + \nabla(\lambda \nabla \cdot \vec{u}) + 2(\nabla \cdot \mu \nabla) \vec{u} + \nabla \times (\mu \nabla \times \vec{u})$$

where \vec{g} is the body acceleration. Most of the terms can be verified by inspection of components; the last two require some straightforward rearrangement for verification. Transformation to various curvilinear coordinate systems follows easily from the vector form. If λ and μ are both constants (a useful approximation for many problems), then

$$\rho \frac{d\vec{u}}{dt} = \rho \vec{g} - \nabla p + (\lambda + \mu) \nabla (\nabla \cdot \vec{u}) + \mu (\nabla \cdot \nabla) \vec{u}$$

The Energy Equation

It is instructive to examine closely the derivation of the energy equation when one has a generalized stress tensor, p_{ij} . We use a method which is much like that of Chapter I, but carried out with slightly more elegance.* Consider a closed surface moving with the fluid

Let

$W_1 \equiv$ rate at which work is being done on the fluid
within by forces at the surface

$W_2 \equiv$ rate at which work is being done on the fluid
within by body forces

*The derivation is essentially an elaboration of that presented in L. Howarth, ed., "Modern Developments in Fluid Dynamics — High Speed Flow," pp. 52-55, Clarendon Press, Oxford, 1953.

THE ENERGY EQUATION

$Q \equiv$ rate at which heat is conducted across the surface
into the fluid within

$K \equiv$ the total kinetic energy within

$d\tau \equiv$ element of volume

The rest of the symbols are as used before.

Conservation of energy then requires

$$\frac{dK}{dt} + \frac{d}{dt} \int \rho I d\tau = W_1 + W_2 + Q \quad (9)$$

where the integral is over the volume; surface integrals will be over the surface.

Consider now an element of area, da , on the surface. Let its outward unit normal vector be n_j . Then $n_j p_{ij} da$ is the total force on the area in the i direction. This, multiplied by the velocity component in the i direction, gives the total flux in that direction, and the sum of these gives the total work flux across the element of area:

$n_j p_{ij} u_i da$. Thus

$$W_1 = \int n_j p_{ij} u_i da$$

which, by the divergence theorem, becomes

$$W_1 = \int \frac{\partial}{\partial x_j} (p_{ij} u_i) d\tau$$

This may be transformed as follows:

$$W_1 = \int u_i \frac{\partial p_{ij}}{\partial x_j} d\tau + \int p_{ij} \frac{\partial u_i}{\partial x_j} d\tau$$

VIII. THEORY OF VISCOSITY

We eliminate $\partial p_{ij}/\partial x_j$ using the momentum equation

$$W_1 = \int \rho u_i \frac{du_i}{dt} d\tau - \int \rho u_i g_i d\tau + \int p_{ij} \frac{\partial u_i}{\partial x_j} d\tau \quad (10)$$

Next, we examine dK/dt . By definition

$$\frac{dK}{dt} = \frac{d}{dt} \int \frac{1}{2} \rho u_i u_i d\tau$$

Since the surface moves with the fluid, $d/dt (\rho d\tau) \equiv 0$, so that

$$\frac{dK}{dt} = \int \rho u_i \frac{du_i}{dt} d\tau \quad (11)$$

Next, the work done by body forces is clearly

$$W_2 \equiv \int \rho u_i g_i d\tau \quad (12)$$

And finally, with k being the heat conduction coefficient,

$$Q = \int k n_i \frac{\partial T}{\partial x_i} da = \int \frac{\partial}{\partial x_i} \left(k \frac{\partial T}{\partial x_i} \right) d\tau \quad (13)$$

Inserting (10) to (13) into (9), and transforming

$$\frac{d}{dt} \int \rho I d\tau \equiv \int \rho \frac{dI}{dt} d\tau$$

we obtain

$$\int \rho \frac{dI}{dt} d\tau = \int \frac{\partial}{\partial x_i} \left(k \frac{\partial T}{\partial x_i} \right) d\tau + \int p_{ij} \frac{\partial u_i}{\partial x_j} d\tau$$

Now this equation must hold for any surface; therefore, it must be true that the integrands form the equation

$$\rho \frac{dI}{dt} = p_{ij} \frac{\partial u_i}{\partial x_j} + \frac{\partial}{\partial x_i} \left(k \frac{\partial T}{\partial x_i} \right) \quad (14)$$

Usually, it is more convenient to work with the total energy per unit mass, $E \equiv I + \frac{1}{2} u_i u_i \equiv I + \frac{1}{2} \vec{u} \cdot \vec{u}$. The energy and momentum equations can be combined in vector form to give

$$\rho \frac{dE}{dt} = \rho \vec{u} \cdot \vec{g} + \nabla \cdot [k \nabla T - p \vec{u} + \lambda \vec{u} (\nabla \cdot \vec{u}) + \frac{1}{2} \mu \nabla (\vec{u} \cdot \vec{u}) + \mu (\vec{u} \cdot \nabla) \vec{u}] \quad (15)$$

Dilatative Dissipation

Any element of a compressible fluid may be expanding or contracting as it moves. Suppose, in particular, that an element is being compressed the same from all sides so that it remains geometrically similar to itself in shape. If we transform our equations to a uniformly moving coordinate system which instantaneously has the average velocity of the element, then the velocity in the vicinity of the element will be $\vec{u} = \kappa \vec{r}$ (where κ is a constant) to lowest order in $|\vec{r}|$. This corresponds to an expansion of the element if $\kappa > 0$ or contraction if $\kappa < 0$. (If the velocity to lowest order were $\vec{u} = ar^n \vec{r}$, then this would correspond to an infinite rate of change of density for $n < 0$ and no rate of change of density for $n > 0$.) Inserting $\vec{u} = \kappa \vec{r}$ into (14) reduces it to

$$\rho \frac{dI}{dt} = \nabla \cdot (k \nabla T) - 3\kappa [p - 3\kappa (\lambda + \frac{2}{3} \mu)]$$

The quantity in brackets is the total pressure defined in (8), and the significance of this quantity now becomes apparent. Unless the dilatation pressure vanishes (by having $\lambda + 2/3 \mu \equiv 0$), then there is a

VIII. THEORY OF VISCOSITY

viscous dissipation in spherically symmetric dilatation.

There are expansions or contractions which do not maintain the geometric similarity of an element. An example is the contraction due to a plane piston pushing against a fluid. For these, vanishing of the dilatation pressure does not remove the dissipation.

There is considerable evidence that many fluids behave as though their first and second coefficients of viscosity were very different, the relation between them being quite variable from fluid to fluid. For such fluids, the dilatation pressure is a real and important quantity.

Discussion of the Dilatation Pressure

In the next section of this chapter it is shown how the total kinetic energy of an aggregate of monatomic molecules can be divided, in macroscopic viewpoints, into kinetic and internal parts. The former results from the mean velocity of all the molecules, while the latter, which really is also a kinetic energy, results from the individual fluctuations from the mean velocity. For more complicated molecules, there is an additional contribution to the internal energy, arising from vibrations and rotations within the molecules themselves. The two atoms of a diatomic molecule, for example, may vibrate along the line between them, or may rotate about either of two axes perpendicular to that line. Thus there are three internal "degrees of freedom" in addition to the three translational degrees (corresponding to motion in each direction of three-dimensional space). Only at high temperatures, however, is the vibrational degree of freedom excited.

DISCUSSION OF THE DILATATION PRESSURE

Statistical mechanical arguments show that in equilibrium of the gas, all "active" degrees of freedom have, on the average, the same amount of energy. (Some degrees, such as the diatomic vibrational one mentioned above, are excluded under some conditions by quantum mechanical effects.) If, however, some influence changes the state of the gas rapidly, then there may be a delay before new equilibrium is reached. The internal motions may be excited or relaxed only after numerous collisions, and so lag behind the changes in translational internal energy. The dilatation pressure arises as a result of this lag.

Let I_1 and I_2 be the specific internal energies associated with the translational and internal degrees of freedom, respectively. We assume that the translational degrees all have the same specific energy, e_1 , and the internal degrees all have the same specific energy, e_2 . Then with a total of n degrees of freedom $I_1 = 3e_1$, $I_2 = (n - 3)e_2$, the total specific internal energy is $I = I_1 + I_2 = 3e_1 + (n - 3)e_2$.

It is also shown in the next section that for a monatomic gas the pressure is given by

$$p = \frac{2}{3} \rho I$$

In that special case, there are no internal degrees of freedom, so that I arises completely from translational energy. Likewise for more complicated molecules, the pressure is still associated with the translational internal energy only, so that, in general,

$$p = \frac{2}{3} \rho I_1$$

VIII. THEORY OF VISCOSITY

Now

$$I_1 \equiv \frac{3}{n} I + \frac{3}{n} (n - 3) (e_1 - e_2)$$

so that

$$p = \frac{2}{n} \rho I + \frac{2}{n} (n - 3) \rho (e_1 - e_2)$$

(Note that in equilibrium, when $e_1 = e_2$, this equation of state is that of a polytropic gas, for which $\gamma - 1 \equiv 2/n$, or

$$\gamma = \frac{n + 2}{n}$$

The validity of this result is well demonstrated by the fact that under most circumstances such diatomic gases as oxygen and hydrogen, which possess five active degrees of freedom, are well represented by $\gamma = 7/5$.)

Next, as an approximate model of nonequilibrium processes, we assume that the energy e_2 is always tending towards e_1 at a rate which is proportional to their difference

$$\alpha \frac{De_2}{Dt} = e_1 - e_2$$

where α is a constant with dimensions of time, the "relaxation time."

Thus the pressure is

$$p = (\gamma - 1) \rho I + \frac{2\alpha}{n} (n - 3) \rho \frac{De_2}{Dt}$$

Finally, we assume that the processes are nearly in equilibrium, so that α is small; the relaxation time is short compared with times for significant change in the gross fluid configuration. Then, since

INTRODUCTION TO RIGOROUS VISCOSITY THEORY

$$\frac{De_2}{Dt} = \frac{1}{n} \frac{DI}{Dt} + \mathcal{O}(\alpha)$$

we get

$$p = (\gamma - 1)\rho I + \frac{2\alpha}{n^2} (n - 3)\rho \frac{DI}{Dt}$$

plus terms proportional to α^2 which are here neglected. Finally, we use the hydrodynamic equation

$$\rho \frac{DI}{Dt} = -p \nabla \cdot \mathbf{u}$$

to obtain

$$p = (\gamma - 1)\rho I - \left[\frac{2\alpha p}{n^2} (n - 3) \right] \nabla \cdot \vec{\mathbf{u}}$$

This is the total pressure, as defined in (8), and comparison with that equation shows that

$$\lambda + \frac{2}{3} \mu \equiv \frac{2\alpha p}{n^2} (n - 3)$$

and thus vanishes for monatomic gases ($n = 3$) or for very fast relaxation ($\alpha = 0$).

Introduction to Rigorous Viscosity Theory

The diffusion approach to derivation of the viscous equations was filled with assumptions which may be accepted as reasonable, but which have no firm basis for argument. A really satisfactory mathematical description of hydrodynamic processes can arise only from a careful examination of the detailed molecular dynamics. We here present a

VIII. THEORY OF VISCOSITY

highly simplified version of such an examination, which, however, introduces many of the features of the more elegant treatments.* We shall see that this new viewpoint will lead to some surprising reinterpretations of previously studied hydrodynamic processes.

We start by reviewing the concept of a gas (to which the present discussion is limited). A gas consists of numerous molecules moving very rapidly with infrequent encounters. We give more precision to this statement as follows:

1. "Numerous" means that within any region of macroscopic space (i.e., any region over which the mean molecular characteristics do not change much), the number of molecules is large compared with one.

2. "Rapidly" means that the velocity of an individual molecule is large compared with the average velocity of its numerous neighbors.

3. "Infrequent" means that a molecule spends nearly 100% of its time traveling in "free space" (i.e., not in interaction with any other molecule).

Consider the following idealized situation. At $t = 0$, a uniform distribution of molecules is moving in a direction normal to a flat rigid wall, all molecules having precisely the same velocity. Each molecule hitting the wall reflects and moves back into the approaching

* See, for example: G. N. Patterson, "Molecular Flow of Gases," John Wiley and Sons, Inc., New York, 1956, for a much more extensive introduction; or the classical treatment in detail: Sydney Chapman and T. G. Cowling, "The Mathematical Theory of Non-Uniform Gases," Cambridge University Press, 1952.

INTRODUCTION TO RIGOROUS VISCOSITY THEORY

cloud with the negative of its original velocity. Thus there arises a widening zone against the wall defined by the motion of the first group of molecules to reflect from the wall. Assume at first that there are no molecular collisions. Then in the zone next to the wall there are just as many molecules moving to the left as to the right, so that the mean velocity of the gas is zero; the gas has "come to rest." The leftward moving boundary of the zone is the "front of a shock." In the zone there is no macroscopic kinetic energy, because the

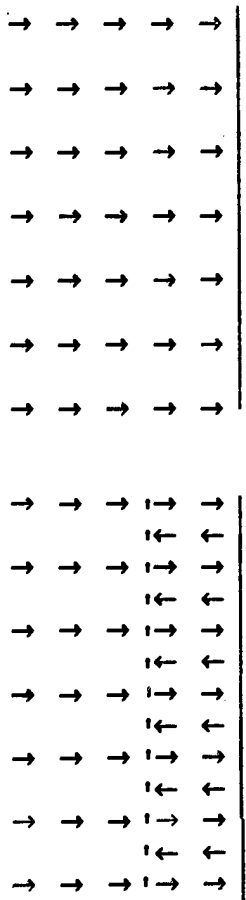

mean gas velocity is zero. The energy of the molecules is now called internal energy, and it is easy to see that the internal energy per unit mass is just equal to the kinetic energy per unit mass of the gas outside of the shock zone. The shock speed relative to the approaching fluid is twice the speed of the fluid itself. (Note that this corresponds to $\gamma = 3$ in our previous treatment of an infinite shock in a polytropic gas. The correspondence is not accidental, as we shall see below.)

The assumption of no molecular collisions is like the assumption of no viscosity in the macroscopic viewpoint. The effect of molecular

VIII. THEORY OF VISCOSITY

encounters is to decrease the mean leftward speed of the reflected particles, particularly of the earliest ones reflected, thus "smearing out" the otherwise-sharp shock.

The individual velocity of molecule j , \vec{u}_j , can be written in terms of the mean velocity in its neighborhood, $\langle \vec{u}_j \rangle$, as

$$\vec{u}_j = \langle \vec{u}_j \rangle + \delta\vec{u}_j$$

Thus $\langle \delta\vec{u}_j \rangle \equiv 0$. Also, since

$$\vec{u}_j^2 = \langle \vec{u}_j \rangle^2 + \delta\vec{u}_j^2 + 2 \langle \vec{u}_j \rangle \cdot \delta\vec{u}_j$$

we obtain

$$\frac{1}{2} \langle \vec{u}_j^2 \rangle = \frac{1}{2} \langle \vec{u}_j \rangle^2 + \frac{1}{2} \langle \delta\vec{u}_j^2 \rangle \quad (16)$$

That is, the average kinetic energy per unit mass of the molecules (which is the true total energy per unit mass) is equal to the kinetic energy per unit mass of the mean motion plus an additional term which can only be identified as I , the internal energy per unit mass, as viewed macroscopically.

The fundamental entity in gas dynamics is the distribution function, f , of molecular velocities. It is defined in such a way that

$$f(\vec{u}, \vec{r}, t) d\vec{r} d\vec{u}$$

is the number of molecules at time t which have velocities in the interval $d\vec{u}$ about \vec{u} and which lie in the space interval $d\vec{r}$ about \vec{r} . We shall suppose throughout that $f \rightarrow 0$ as $|\vec{u}| \rightarrow \pm \infty$, sufficiently rapidly that all desired integrals converge. Then, with $M \equiv$ molecule mass,

INTRODUCTION TO RIGOROUS VISCOSITY THEORY

$$M \int_{-\infty}^{\infty} Q(\vec{u}) f(\vec{u}, \vec{r}, t) d\vec{u} \equiv \rho(\vec{r}, t) \langle Q \rangle \quad (17)$$

where $Q(\vec{u})$ is any function of \vec{u} for which an average may be desired, and $\rho(\vec{r}, t)$ is the macroscopic density, mass per unit volume.

The distribution function is the subject of Liouville's Theorem, which is the basic starting place for the derivations to follow. It can be stated: Along the motion of any particle, $f(\vec{u}, \vec{r}, t)$ is a constant; that is

$$\frac{d}{dt} f(\vec{u}, \vec{r}, t) = 0 \quad (18)$$

To demonstrate the validity of this theorem, we consider the integral of f over some region of six dimensional coordinate-velocity space

$$\iint f(\vec{u}, \vec{r}, t) d\vec{u} d\vec{r}$$

This integral represents the total number of particles within the region of integration; that is, the total number of particles whose coordinates lie within the spatial part of the region and whose velocities lie within the velocity part. Now suppose that the region of integration moves in such a way that a particle on its surface remains always on its surface. Then no particle away from the surface can ever come to lie thereon, and the number of interior particles is forever constant.

$$\frac{d}{dt} \iint f(\vec{u}, \vec{r}, t) d\vec{u} d\vec{r} = 0$$

The rule for such differentiation, (I-3), can be generalized to this

VIII. THEORY OF VISCOSITY

six-dimensional case; with the summation convention for the integrand,

$$\iiint \left[\frac{\partial f}{\partial t} + \frac{\partial f u_j}{\partial x_j} + \frac{\partial f (Du_j/Dt)}{\partial u_j} \right] d\vec{u} d\vec{r} = 0$$

or

$$\iiint \frac{Df}{Dt} d\vec{u} d\vec{r} + \iiint f \left[\frac{\partial u_j}{\partial x_j} + \frac{\partial (Du_j/Dt)}{\partial u_j} \right] d\vec{u} d\vec{r} = 0$$

Now the partial derivatives in the bracket are with respect to the independent variables x_j , u_j , and t , so that $\partial u_j / \partial x_j \equiv 0$. Also, we shall assume the forces on the particles are independent of velocity, so that

$$m \frac{Du_j}{Dt} = F_j(\vec{r}, t)$$

as a result of which $\partial (Du_j/Dt) / \partial u_j = 0$. (The assumption of velocity-independent forces is not restrictive for our present purposes.) Thus

$$\iiint \frac{Df}{Dt} d\vec{u} d\vec{r} = 0$$

must hold for any arbitrary region of integration and the integrand must vanish identically.

We now carry out the differentiation indicated in (18) and write the result in component form

$$\frac{\partial f}{\partial t} + \frac{\partial f}{\partial x_j} \frac{Dx_j}{Dt} + \frac{\partial f}{\partial u_j} \frac{Du_j}{Dt} = 0$$

or

$$\frac{\partial f}{\partial t} + u_j \frac{\partial f}{\partial x_j} + \frac{F_j}{m} \frac{\partial f}{\partial u_j} = 0 \quad (19)$$

INTRODUCTION TO RIGOROUS VISCOSITY THEORY

This is called the Liouville Equation.

As a simple example of the derivation of hydrodynamic equations, we consider the special case in which the molecules are confined to move in one direction only (chosen parallel to the x-axis), and all quantities of interest are functions of that coordinate only. Then (19) becomes

$$\frac{\partial f}{\partial t} + u \frac{\partial f}{\partial x} + \frac{F}{m} \frac{\partial f}{\partial u} = 0$$

Multiply this by $Q(u)$ and integrate over all values of u . Then

$$\int_{-\infty}^{\infty} \left\{ Q \frac{\partial f}{\partial t} + Qu \frac{\partial f}{\partial x} + Q \frac{F}{m} \frac{\partial f}{\partial u} \right\} du = 0$$

or

$$\frac{\partial}{\partial t} \int_{-\infty}^{\infty} Qf \, du + \frac{\partial}{\partial x} \int_{-\infty}^{\infty} Qu \, f \, du + \frac{F}{m} \int_{-\infty}^{\infty} \left[\frac{\partial Qf}{\partial u} - f \frac{\partial Q}{\partial u} \right] du = 0$$

from which

$$\frac{\partial \rho \langle Q \rangle}{\partial t} + \frac{\partial \rho \langle Qu \rangle}{\partial x} - \frac{\rho F}{m} \left\langle \frac{\partial Q}{\partial u} \right\rangle = 0 \quad (20)$$

If, for example, $Q \equiv 1$, then

$$\frac{\partial \rho}{\partial t} + \frac{\partial \rho \langle u \rangle}{\partial x} = 0 \quad (21)$$

which is the familiar conservation-of-mass equation with a rigorous interpretation of the velocity therein.

The other two conservation equations (I-24) can also be derived.

VIII, THEORY OF VISCOSITY

In (20) put $u = \langle u \rangle + \delta u$. Then

$$\frac{\partial \rho \langle Q \rangle}{\partial t} + \frac{\partial \rho \langle Q \rangle \langle u \rangle}{\partial x} + \frac{\partial \rho \langle Q \delta u \rangle}{\partial x} = \frac{\rho F}{m} \langle \frac{\partial Q}{\partial u} \rangle \quad (22)$$

Let $Q = u$. Then this becomes the momentum equation

$$\frac{\partial \rho \langle u \rangle}{\partial t} + \frac{\partial \rho \langle u \rangle^2}{\partial x} + \frac{\partial \rho \langle u \delta u \rangle}{\partial x} = \frac{\rho F}{m}$$

The quantity F/m is the force per unit mass exerted on the fluid. Also, $\langle u \delta u \rangle \equiv \langle (\langle u \rangle + \delta u) \delta u \rangle \equiv \langle (\delta u)^2 \rangle$. In this enforced true one-dimensional case, there can be no viscosity. A molecular encounter can only result in a direct back scatter which, to conserve energy and momentum, is equivalent to no encounter at all. This means that we must identify $\rho \langle (\delta u)^2 \rangle$ with the pressure in the gas:

$$p = \rho \langle (\delta u)^2 \rangle \quad (23)$$

Next we let $Q \equiv \frac{1}{2} u^2$, so that

$$\begin{aligned} \langle Q \rangle &= \frac{1}{2} \langle (\langle u \rangle + \delta u)^2 \rangle = \frac{1}{2} \langle u^2 \rangle + \frac{1}{2} \langle (\delta u)^2 \rangle \\ &\equiv K + I \end{aligned}$$

the sum of the specific kinetic and internal energies — see (16) and the discussion following. Thus (22) becomes

$$\frac{\partial \rho (K + I)}{\partial t} + \frac{\partial}{\partial x} [\rho \langle u \rangle (K + I)] + \frac{\partial}{\partial x} [\rho \langle \frac{1}{2} u^2 \delta u \rangle] = \frac{\rho F \langle u \rangle}{m}$$

Now

$$\begin{aligned} \langle u^2 \delta u \rangle &= \langle (\langle u \rangle^2 + 2\langle u \rangle \delta u + \delta u^2) \delta u \rangle = 2\langle u \rangle \langle (\delta u)^2 \rangle + \langle (\delta u)^3 \rangle \\ &= \frac{2}{\rho} \langle u \rangle p + \langle (\delta u)^3 \rangle \end{aligned}$$

INTRODUCTION TO RIGOROUS VISCOSITY THEORY

so that

$$\frac{\partial \rho(K + I)}{\partial t} + \frac{\partial}{\partial x} [\rho \langle u \rangle (K + I)] + \frac{\partial \rho \langle u \rangle}{\partial x} = \rho \frac{F \langle u \rangle}{m} - \frac{\partial}{\partial x} \left[\frac{\rho}{2} \langle (\delta u)^3 \rangle \right]$$

The terms on the right show the generalization of (I-24). The first one is the work done by the force on the gas; the second one is a heat conduction term.

Note that the identifications

$$p = \rho \langle (\delta u)^2 \rangle$$

$$I = \frac{1}{2} \langle (\delta u)^2 \rangle$$

lead to the equation of state

$$p = 2\rho I$$

which is the polytropic equation of state with $\gamma = 3$.

Much more realistic is this same treatment applied to a three-dimensional gas. Multiply (19) by $Q(u_1, u_2, u_3)$ and integrate over all velocity space. Then, in the same way as above,

$$\frac{\partial \rho \langle Q \rangle}{\partial t} + \frac{\partial}{\partial x_j} [\rho \langle u_j \rangle \langle Q \rangle + \rho \langle Q \delta u_j \rangle] = \frac{F_j}{m} \rho \langle \frac{\partial Q}{\partial u_j} \rangle \quad (24)$$

With $Q \equiv 1$, we get the mass conservation equation

$$\frac{\partial \rho}{\partial t} + \frac{\partial \rho \langle u_j \rangle}{\partial x_j} = 0 \quad (25)$$

With $Q \equiv u_i$, we get the momentum conservation equation

VIII. THEORY OF VISCOSITY

$$\frac{\partial \rho \langle u_i \rangle}{\partial t} + \frac{\partial}{\partial x_j} [\rho \langle u_i \rangle \langle u_j \rangle + \rho \langle \delta u_i \delta u_j \rangle] = \frac{\rho F_i}{m} \quad (26)$$

This is to be compared with (6), (in which equation $F_i \equiv 0$). With $Q \equiv \frac{1}{2} u_i^2$, so that $\langle Q \rangle = \frac{1}{2} \langle u_i \rangle^2 + \frac{1}{2} \langle (\delta u_i)^2 \rangle \equiv K + I$, we get the energy conservation equation

$$\begin{aligned} \frac{\partial \rho (K + I)}{\partial t} + \frac{\partial}{\partial x_j} [\rho \langle u_j \rangle (K + I) + \rho \langle u_i \rangle \langle \delta u_i \delta u_j \rangle] \\ = \frac{\rho F_j u_j}{m} - \frac{\partial}{\partial x_j} [\frac{1}{2} \rho \langle (\delta u_i)^2 \delta u_j \rangle] \end{aligned} \quad (27)$$

The generalized stress tensor, corresponding to (7), is thus

$$p_{ij} = - \rho \langle \delta u_i \delta u_j \rangle \quad (28)$$

so that the total pressure, analogous to (8), is

$$p_T = \frac{1}{3} \rho \langle (\delta u_i)^2 \rangle \quad (29)$$

Because $I \equiv \frac{1}{2} \langle (\delta u_i)^2 \rangle$, we are led to the equation of state

$$p = \frac{2}{3} \rho I$$

which is the polytropic equation for a gas with $\gamma = 5/3$. This supports the assertion in earlier chapters that a monatomic gas has this form of state equation.

This discussion serves only as an introduction to the rigorous study of gas dynamics. The next step, which we shall not here follow,

INTRODUCTION TO RIGOROUS VISCOSITY THEORY

is to determine the distribution function for situations of interest. With it, one can then perform the averaging integrations. The formulation requires the use of additional physical principles, and leads to the famous Boltzmann equation. The subsequent manipulations are long and tedious, but generally rewarding in their results. They lead to the stress tensor (7) as the lowest order approximation to reality, and predict the dependence of λ and μ on the details of molecular structure. They also lead to higher order corrections to the stress tensor — in principle the results can be as accurate as desired. The reader is directed to the references cited earlier in this chapter for the detailed discussion and for additional bibliography.

CHAPTER IX

EXAMPLES OF VISCOUS AND CONDUCTING FLOWS

The Equations Specialized

To illustrate some of the properties of viscous and conducting flows, we present a few specialized solutions. Many more of these are available in numerous books and papers.*

We specialize to plane, two-dimensional flow, in which case the appropriate equations are

$$\rho \frac{du}{dt} = \rho g_x - \frac{\partial p}{\partial x} + \frac{\partial}{\partial x} \left[(\lambda + 2\mu) \frac{\partial u}{\partial x} + \lambda \frac{\partial v}{\partial y} \right] + \frac{\partial}{\partial y} \left[\mu \left(\frac{\partial u}{\partial y} + \frac{\partial v}{\partial x} \right) \right] \quad (1)$$

$$\rho \frac{dv}{dt} = \rho g_y - \frac{\partial p}{\partial y} + \frac{\partial}{\partial y} \left[(\lambda + 2\mu) \frac{\partial v}{\partial y} + \lambda \frac{\partial u}{\partial x} \right] + \frac{\partial}{\partial x} \left[\mu \left(\frac{\partial u}{\partial y} + \frac{\partial v}{\partial x} \right) \right] \quad (2)$$

$$\begin{aligned} \rho \frac{dE}{dt} = & \rho (u g_x + v g_y) + \frac{\partial}{\partial y} \left(k \frac{\partial T}{\partial y} \right) + \frac{\partial}{\partial x} \left(k \frac{\partial T}{\partial x} \right) - \frac{\partial p u}{\partial x} - \frac{\partial p v}{\partial y} \\ & + \frac{\partial}{\partial x} \left[\lambda u \left(\frac{\partial u}{\partial x} + \frac{\partial v}{\partial y} \right) \right] + \frac{\partial}{\partial y} \left[\lambda v \left(\frac{\partial u}{\partial x} + \frac{\partial v}{\partial y} \right) \right] \\ & + \frac{\partial}{\partial x} \left[\mu \left(u \frac{\partial u}{\partial x} + v \frac{\partial v}{\partial x} \right) \right] + \frac{\partial}{\partial y} \left[\mu \left(u \frac{\partial u}{\partial y} + v \frac{\partial v}{\partial y} \right) \right] \\ & + \frac{\partial}{\partial x} \left[\mu \left(u \frac{\partial u}{\partial x} + v \frac{\partial u}{\partial y} \right) \right] + \frac{\partial}{\partial y} \left[\mu \left(u \frac{\partial v}{\partial x} + v \frac{\partial v}{\partial y} \right) \right] \end{aligned} \quad (3)$$

*See, for example, S. Pai, "Viscous Flow Theory, I-Laminar Flow," D. Van Nostrand Company, Inc., Princeton, 1956.

THE EQUATIONS SPECIALIZED

Here u and v are the velocities in the x and y directions, respectively, and g_x, g_y are the corresponding accelerations due to exterior forces. The quantity, k , is the heat conduction coefficient. $E \equiv I + \frac{1}{2}(u^2 + v^2)$.

We shall limit our discussion to polytropic gases for which $p = (\gamma - 1)\rho I$. We shall further simplify the equations by additional assumptions:

1. The two coefficients of viscosity are proportional to each other: $\lambda \equiv A\mu$ where A is a dimensionless constant. (The special case in which $\lambda + 2/3 \mu \equiv 0$ is included.) In general, $A \geq -2/3$.

2. The simplest model of a gas predicts that the heat conduction coefficient and viscosity coefficient are related to the specific heat (here a constant) in such a way that

$$k \frac{\partial T}{\partial x} \equiv \mu B \frac{\partial I}{\partial x}$$

where B is a dimensionless constant related to γ by

$$B = \frac{2\gamma - 5}{4} \tag{4}$$

We shall assume this to be true for all cases discussed.

The equations can be rearranged and condensed considerably, especially with introduction of the abbreviations

$$P \equiv -p + \mu A \left(\frac{\partial u}{\partial x} + \frac{\partial v}{\partial y} \right) \tag{5}$$

$$Q \equiv \mu \left(\frac{\partial v}{\partial x} + \frac{\partial u}{\partial y} \right) \tag{6}$$

Then

IX. EXAMPLES OF VISCOUS AND CONDUCTING FLOWS

$$\rho \frac{du}{dt} = \rho g_x + \frac{\partial}{\partial x} (P + 2\mu \frac{\partial u}{\partial x}) + \frac{\partial Q}{\partial y} \quad (7)$$

$$\rho \frac{dv}{dt} = \rho g_y + \frac{\partial}{\partial y} (P + 2\mu \frac{\partial v}{\partial y}) + \frac{\partial Q}{\partial x} \quad (8)$$

$$\begin{aligned} \rho \frac{dE}{dt} &= \rho (u g_x + v g_y) \\ &+ \frac{\partial}{\partial x} [Pu + Qv + \mu \frac{\partial}{\partial x} (BI + u^2)] \\ &+ \frac{\partial}{\partial y} [Pv + Qu + \mu \frac{\partial}{\partial y} (BI + v^2)] \end{aligned} \quad (9)$$

We shall not try to work with these equations even in this relatively simplified form, but shall specialize even further. Suppose, for example, that all quantities are independent of x , and $g_y \equiv 0$. Then

$$\rho \left(\frac{\partial u}{\partial t} + v \frac{\partial u}{\partial y} \right) = \rho g_x + \frac{\partial}{\partial y} \left(\mu \frac{\partial u}{\partial y} \right) \quad (10)$$

$$\rho \left(\frac{\partial v}{\partial t} + v \frac{\partial v}{\partial y} \right) = \frac{\partial}{\partial y} \left[-p + \mu(A + 2) \frac{\partial v}{\partial y} \right] \quad (11)$$

$$\rho \left(\frac{\partial E}{\partial t} + v \frac{\partial E}{\partial y} \right) = \rho u g_x + \frac{\partial}{\partial y} \left\{ -pv + \mu \frac{\partial}{\partial y} \left[\left(1 + \frac{A}{2}\right) v^2 + \frac{1}{2} u^2 + BI \right] \right\} \quad (12)$$

Diffusion of the Viscous Effect

Consider the problem of determining the motion of a semi-infinite gas adjacent to a flat plate at $y = 0$. The plate commences impulsively to move at $t = 0$ with velocity u_0 parallel to itself. We assume that u_0 is small enough that viscous heating of the gas is negligible. Then μ and ρ can be considered constants, and v is effectively zero. Under these circumstances, (10) alone is sufficient; it becomes, with $\mu/\rho \equiv \nu$,

DIFFUSION OF THE VISCOUS EFFECT

$$\frac{\partial u}{\partial t} = \nu \frac{\partial^2 u}{\partial y^2} \quad (13)$$

We note, from arguments of dimensionality, that the solution must be a function of $y/\sqrt{\nu t}$ only. Substituting this into (13), one obtains an easily solved, ordinary differential equation. Application of the boundary conditions yields

$$u = u_0 \left(1 - \frac{2}{\sqrt{\pi}} \int_0^{y/2\sqrt{\nu t}} e^{-z^2} dz \right) \quad (14)$$

What is the thickness of the disturbed area after the plate has moved a distance L ? The thickness is defined as the distance to the point at which $u = 1/2 u_0$. At that point, $y_1 = 0.954 \sqrt{\nu t} \approx \sqrt{\nu t}$. But $t = L/u_0$ so that

$$\frac{y_1}{L} \approx \sqrt{\frac{\nu}{Lu_0}} \quad (15)$$

For air, for example, $\nu \approx 0.156 \text{ cm}^2/\text{sec}$. Thus, if the plate moves at, say, 1000 cm/sec (well below the speed of sound at ordinary conditions), then, when $L = 100 \text{ cm}$, the thickness of the "boundary layer" is only 0.125 cm. The extreme thinness of this layer for objects moving through air has led to a large, highly successful field of approximate viscous hydrodynamics called boundary-layer theory. Outside of this layer, nonviscous flow theory is appropriate. Within it, special techniques are required.

Problems concerning vehicles or projectiles traveling through

IX. EXAMPLES OF VISCOUS AND CONDUCTING FLOWS

air can often be solved without requiring the use of general viscous theory. This is true when the boundary layer is always in thickness a negligible fraction of the size of the important components of the system. A vast and important amount of literature treats many interesting phases of these boundary-layer problems — stability, resistance, heat transfer, etc. We shall not be concerned further with these problems here.

The quantity on the right of (15) is of special significance. If L is the length of a projectile, then $\sqrt{\nu/Lu_0}$ is a measure of the relative influence of the boundary layer on the external flow characteristics. The quantity $R_e \equiv Lu_0/\nu$ is called the Reynolds number for the flow. It arises frequently in problems of viscous flow. Such quantities as drag and lift coefficients are often expressed as functions of it.

It is not, perhaps, inappropriate to notice that the formula for force per unit areas on the plate $F = \mu (\partial u/\partial y)_{y=0}$ follows easily from (13). The momentum per unit plate area of the fluid above the plate is $\int_0^\infty \rho u dy$. Thus, from (13), its time rate of change is

$$\mu \int_0^\infty \frac{\partial^2 u}{\partial y^2} dy = - \mu \left(\frac{\partial u}{\partial y} \right)_{y=0}$$

This is the force on the fluid, which is equal and opposite to that on the plate. In the problem at hand,

$$F = - u_0 \sqrt{\frac{\mu \rho}{\pi t}}$$

DIFFUSION OF THE VISCOUS EFFECT

Suppose that, in this nonsteady problem, the plate remained fixed but that there was initially some velocity distribution. How fast does this smooth itself out due to viscosity? It is still appropriate to use (13). We expand the velocity function into Fourier integrals

$$u(y,t) = \frac{1}{2\pi} \int_{-\infty}^{\infty} \int_{-\infty}^{\infty} A_{k\omega} e^{ikx} e^{i\omega t} dk d\omega$$

Substitution of this into (13) shows that it is a solution provided

$$A_{k\omega} (i\omega + \nu k^2) = 0$$

or

$$A_{k\omega} = A_k \delta(i\omega + \nu k^2)$$

where $\delta(x)$ is the Dirac delta function

$$\begin{aligned} \delta(x) &\equiv 0, & x &\neq 0 \\ \int_{-a}^{+b} \delta(x) dx &= 1, & a, b &> 0 \end{aligned}$$

Thus, the general solution of (13) is:

$$u(y,t) = \frac{1}{2\pi} \int_{-\infty}^{\infty} A_k e^{ikx} e^{-\nu k^2 t} dk \quad (16)$$

This shows that a component of the solution with wavelength $\lambda = 2\pi/k$ decays exponentially, dropping to $1/e$ of its value in time $\lambda^2/4\nu$. In air, for example, if the disturbance is of length 100 cm, its "decay time" is ≈ 400 sec.

IX. EXAMPLES OF VISCOUS AND CONDUCTING FLOWS

Two Steady-State Solutions

These two problems concern the flow between parallel plates. In the first one, there is no external force; the lower plate is moving with constant velocity u_0 . In the second one, the lower plate is at rest and a constant acceleration is felt by the gas, parallel to the channel. In each case, the v component of velocity is zero, so that (10), (11), (12) become

$$\left. \begin{aligned} \rho g + \frac{\partial}{\partial y} \left(\mu \frac{\partial u}{\partial y} \right) &= 0 \\ \frac{\partial p}{\partial y} &= 0 \\ \rho u g + \frac{\partial}{\partial y} \left[\mu \frac{\partial}{\partial y} \left(\frac{1}{2} u^2 + BI \right) \right] &= 0 \end{aligned} \right\} \quad (17)$$

In problem 1, $g = 0$, and the equations can be integrated [with $p \equiv (\gamma - 1)\rho I$] to give

$$\left. \begin{aligned} \mu \frac{\partial u}{\partial y} &= \alpha \\ \rho I &= \beta \\ \mu \left(B \frac{\partial I}{\partial y} + u \frac{\partial u}{\partial y} \right) &= \sigma \end{aligned} \right\} \quad (18)$$

where α , β and σ are constants.

It is not yet necessary to specify the manner in which μ varies.

Let

$$\frac{\partial u}{\partial y} \equiv \frac{\partial u}{\partial I} \frac{\partial I}{\partial y}$$

This is valid provided that y can be eliminated from the equations.

TWO STEADY-STATE SOLUTIONS

We substitute this into (18) and eliminate the terms with y , obtaining

$$B + u \frac{\partial u}{\partial I} = \frac{\sigma}{\alpha} \frac{\partial u}{\partial I}$$

for which μ is also eliminated. This can be integrated to give

$$IB + \frac{1}{2} u^2 = \frac{\sigma}{\alpha} u + \text{constant} \quad (19)$$

As an example, suppose that both wall temperatures are held fixed so that $I = I_0$ at top and bottom. Then

$$BI + \frac{1}{2} u^2 = \frac{1}{2} uu_0 + BI_0$$

At mid-channel, we thus have

$$I = I_0 + \frac{u_0^2}{8B}$$

To proceed with the complete solution we must specify the variation of μ . The strongest variation of μ in most gases is with temperature; we assume that

$$\mu = \mu_0 I^n$$

where μ_0 and n are constants. From (18)

$$\mu_0^2 I^n \frac{\partial}{\partial y} \left(I^n \frac{\partial I}{\partial y} \right) + \frac{\alpha^2}{B} = 0$$

From this may be obtained the first integral

$$I^n \frac{\partial I}{\partial y} = \sqrt{C^2 - \frac{2 \alpha^2 I}{B \mu_0^2}} \quad (20)$$

IX. EXAMPLES OF VISCOUS AND CONDUCTING FLOWS

wherein C^2 is a constant of integration. A second integral is easily obtained for certain values of n (such as 0, $\frac{1}{2}$, 1); for others, the integration can be performed numerically. Qualitatively, the solutions appear as shown in the figure, in which the ordinate is I/I_m or u/u_o .

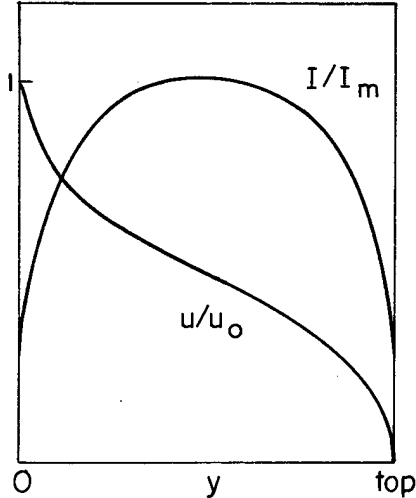

If $n = 0$, then $u(y)$ is linear and $I(y)$ is quadratic.

For the case in which I varies little from its maximum value, I_m , it is possible to obtain an approximate solution

$$I = I_m - \frac{1}{2B} \left(\frac{\delta u}{\delta y} \right)^2 (y_m - y)^2$$

where δu is the total change in velocity over the channel width, δy , and y_m is the height of the channel center.

In problem 2, we take $\mu \equiv \text{constant}$. Then (17) becomes

$$\rho g + \mu \frac{\partial^2 u}{\partial y^2} = 0$$

$$\frac{\partial \rho I}{\partial y} = 0$$

$$B \frac{\partial^2 I}{\partial y^2} + \left(\frac{\partial u}{\partial y} \right)^2 = 0$$

It is straightforward to obtain the lowest order solution for g small:

$$I = I_o + \left(\frac{g \rho_o}{\mu} \right)^2 \left(\frac{y_m}{12B} \right)^4 \left[1 - \left(\frac{y}{y_m} - 1 \right)^4 \right]$$

$$u = \frac{g \rho_o}{2\mu} y(2 y_m - y)$$

TWO STEADY-STATE SOLUTIONS

where $I \equiv I_0$ at top and bottom, and ρ_0 is the average density. Note that

$$I_m = I_0 + \frac{u_m^2}{3B}$$

so that the central material speed can be a fairly large fraction of the initial sound speed before the approximate solution is no longer valid.

We may proceed to obtain an approximation to the build-up of this steady-state solution. We begin with

$$\frac{\partial u}{\partial t} = g + v \frac{\partial^2 u}{\partial y^2} \quad (21)$$

where $v \equiv \mu/\rho$. This equation comes from (10) in which we put $v \equiv 0$ and $\mu \equiv \text{constant}$. Using the result of (16), we could write the solution immediately

$$u = gt + \frac{1}{2\pi} \int_{-\infty}^{\infty} A(k) e^{ikx} e^{-vk^2 t} dk$$

and put into this the boundary conditions that $u \equiv 0$ at $y = 0, y = 2y_m$.

We proceed instead as follows. Assume that there exists a solution

$$u = \Psi(t) \left(y - \frac{y^2}{2y_m} \right)$$

Substitution of this into (21) gives an equation for Ψ

$$\left(y - \frac{y^2}{2y_m} \right) \frac{d\Psi}{dt} = g - \frac{\Psi v}{y_m}$$

The assumed solution is clearly wrong; the signal from the edges affects gradually the otherwise uniformly accelerating gas. Nevertheless, the following analysis gives a good representation of the gross gas behavior.

IX. EXAMPLES OF VISCOUS AND CONDUCTING FLOWS

Since the equation for Ψ must not depend upon y , we replace the equation by its average over the channel

$$\frac{1}{3} y_m^2 \frac{d\Psi}{dt} = g y_m - \Psi v$$

or

$$\frac{d\Psi}{dt} + \frac{3v}{y_m^2} \Psi = \frac{3g}{y_m}$$

This has the solution (in which $\Psi = 0$ at $t = 0$)

$$\Psi = \frac{g y_m}{v} \left[1 - \exp\left(-\frac{3 vt}{y_m^2}\right) \right]$$

This leads to an expression for u which can be integrated over the channel to give the time dependence of the momentum per unit length

$$\frac{2}{3} \frac{\rho g y_m^3}{v} \left[1 - \exp\left(-\frac{3 vt}{y_m^2}\right) \right]$$

Comparison of this result with that obtained by numerical integration of the exact equations shows surprisingly good agreement for the approximation.

Finite Thickness of Shocks

The inclusion of viscosity and heat-conduction effects in the hydrodynamic equations can remove the tendency for solutions to become discontinuous, shocks being replaced by narrow zones over which the fluid characteristics vary rapidly but continuously. To illustrate this, we examine in detail the structure of a one-dimensional compression wave moving unchanged through a polytropic gas, which is at

FINITE THICKNESS OF SHOCKS

rest at $x = +\infty$. The appropriate equations are derived from (7) and (9), together with the mass equation:

$$\frac{\partial \rho}{\partial t} + \frac{\partial \rho u}{\partial x} = 0$$

$$\rho \frac{\partial u}{\partial t} + \rho u \frac{\partial u}{\partial x} = \frac{\partial}{\partial x} \left(\rho_0 \sigma \frac{\partial u}{\partial x} - p \right)$$

$$\rho \frac{\partial}{\partial t} \left(I + \frac{1}{2} u^2 \right) + \rho u \frac{\partial}{\partial x} \left(I + \frac{1}{2} u^2 \right) = \frac{\partial}{\partial x} \left(-pu + \rho_0 \sigma u \frac{\partial u}{\partial x} + \rho_0 \zeta \frac{\partial I}{\partial x} \right)$$

where $\rho_0 \sigma \equiv \lambda + 2\mu$ and $\rho_0 \zeta \equiv B\mu$, and ρ_0 is the initial density. We look for a traveling wave solution, in which all quantities are functions of $x - vt$ only. The constant velocity, v , will then be the rate of propagation of the wave. Thus, with $y \equiv x - vt$

$$\frac{d}{dy} (-v\rho + \rho u) = 0$$

$$(-v\rho + \rho u) \frac{du}{dy} = \frac{d}{dy} \left(\rho_0 \sigma \frac{du}{dy} - p \right)$$

$$(-v\rho + \rho u) \frac{d}{dy} \left(I + \frac{1}{2} u^2 \right) = \frac{d}{dy} \left(-pu + \rho_0 \sigma u \frac{du}{dy} + \rho_0 \zeta \frac{dI}{dy} \right)$$

These may be integrated once; we apply the boundary conditions that at $x = +\infty$, $u = 0$, $\rho = \rho_0$, $p = p_0$, $I = I_0$, and $du/dy = dI/dy = 0$. Then

$$-v\rho + \rho u = -v\rho_0$$

$$-v\rho_0 u = \rho_0 \sigma \frac{du}{dy} - p + p_0$$

$$-v\rho_0 \left(I + \frac{1}{2} u^2 \right) = -pu + \rho_0 \sigma u \frac{du}{dy} + \rho_0 \zeta \frac{dI}{dy} - v\rho_0 I_0$$

We put $p \equiv (\gamma - 1) \rho I$, and ρ is readily eliminated to give

IX. EXAMPLES OF VISCOUS AND CONDUCTING FLOWS

$$-vu = \sigma \frac{du}{dy} - \frac{(\gamma - 1) Iv}{v - u} + (\gamma - 1) I_0 \quad (22)$$

$$v(I_0 - I) - \frac{1}{2} v u^2 = -(\gamma - 1) \frac{uvI}{v - u} + \sigma u \frac{du}{dy} + \zeta \frac{dI}{dy} \quad (23)$$

Next we eliminate I (but not dI/dy):

$$\zeta \frac{dI}{dy} + \frac{v - u}{\gamma - 1} \sigma \frac{du}{dy} = \frac{u}{\gamma - 1} \left(c_0^2 - v^2 + \frac{\gamma + 1}{2} uv \right) \quad (24)$$

where $c_0^2 \equiv \gamma(\gamma - 1) I_0$ is the square of the far-right sound speed. Note that if ζ and σ are both zero, then either $u = 0$ or $2(c_0^2 - v^2) + (\gamma + 1) uv = 0$. These two end conditions exactly characterize a shock [see IV-(17)], and thus justify association of the results with the structure of a shock.

We shall now consider two extreme cases in which $\sigma \equiv 0$ or $\zeta = 0$. Many more details than we shall present, as well as discussions of in-between cases, have been given in articles such as that by Hayes.* Even though in all real gases the effects of viscosity and heat conduction are of nearly equal importance, there is still interest in these two extreme cases. With viscosity only, the results are applicable to analysis of certain finite-difference-approximation methods which employ "artificial viscosity" to improve their results. With conduction only, the analysis refers to a gas in which radiation is transported. The true shock structure in a real gas does not differ qualitatively from that in the viscosity-only case. The results of the conduction-only case

*W. D. Hayes, in "Fundamentals of Gas Dynamics," H. W. Emmons, ed., Vol. III, Section D, Princeton University Press, 1958.

show that a discontinuity may still be present even if ζ is very large.

Case I, Viscosity Only. With $\zeta \equiv 0$, Eq. (24) is easily integrable if σ is constant; the qualitative features can be seen even with variable σ . The equation becomes

$$\sigma \frac{du}{dy} = \frac{u}{v - u} \left(c_0^2 - v^2 + \frac{\gamma + 1}{2} uv \right)$$

Since σ is always positive, and the right side is always negative and finite for u between its extreme values, there is always a smooth transition through the "shock region." The velocity profile appears as shown in the figure

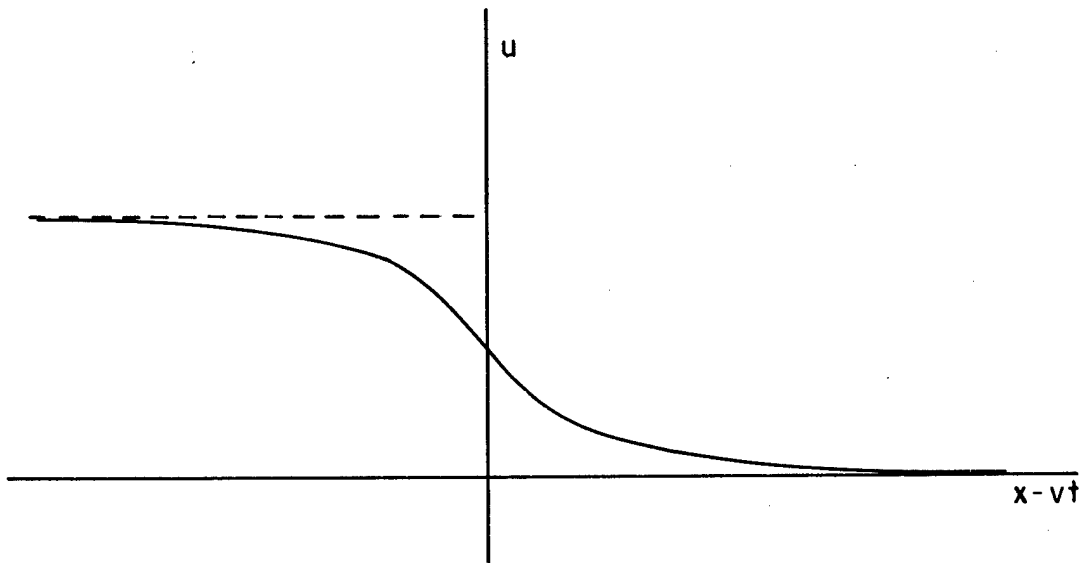

The width of the shock can be defined as

$$w = \left| \frac{u}{du/dx} \right|_0$$

where subzero refers to the point at which u has decreased to half its value at $x = -\infty$. Thus

IX. EXAMPLES OF VISCOUS AND CONDUCTING FLOWS

$$u_o = \frac{1}{\gamma + 1} \left(v - \frac{c_o^2}{v} \right)$$

$$\left(\frac{du}{dx} \right)_o = - \frac{\left(v^2 - c_o^2 \right)^2}{2\sigma \left(\gamma v^2 + c_o^2 \right)}$$

and

$$w = \frac{2\sigma(\gamma v^2 + c_o^2)}{(\gamma + 1)v(v^2 - c_o^2)} \quad (25)$$

For a weak shock ($v \approx c_o$) the shock width may become large. For a shock of infinite strength ($c_o = 0$) the width becomes

$$w_\infty = \frac{2\sigma\gamma}{(\gamma + 1)v}$$

For normal air, for example, $\sigma \approx 0.15 \text{ cm}^2/\text{sec}$ and $\gamma = 1.4$, so that for a strong shock

$$w \approx \frac{0.18}{v} \text{ cm}$$

where v is measured in cm/sec . Normal air sound speed is about $3.3 \times 10^4 \text{ cm}/\text{sec}$; the speed of a strong shock would be much greater so that w would be much less than $5 \times 10^{-6} \text{ cm}$ — a very short distance in most situations of interest.

Even for a weak shock, the thickness may be quite small. In the weak-shock limit,

$$w \approx \frac{4 \gamma \sigma}{(\gamma + 1) c_o} \left(\frac{p}{\delta p} \right)$$

where p is the average pressure and δp is the change in pressure across the shock. For normal air, this becomes

$$w \approx 1 \times 10^{-5} \left(\frac{p}{\delta p} \right) \text{ cm}$$

so that even if δp were 1% of p , the shock thickness would only be about 0.001 cm.

Case II, Conduction Only. With $\sigma \equiv 0$, (22) becomes a relation between u and I from which we may observe directly some of the features of interest. The results have been given in detail by Landau and Lifshitz.* With finite heat conductivity, I must be continuous and monotonically increasing towards the left. Consider, however, the root of (22) which starts at the far right with $u = 0$, $I = I_0$. As u increases, so also does I , and if the shock is strong enough, I will reach its far-left value before u does. At this point a discontinuity must occur in which u changes to the other root of (22) for which I equals its far-left value. The result is an "isothermal discontinuity" in velocity and density. The velocity profile is shown qualitatively in the following figure.

*L. D. Landau and E. M. Lifshitz, "Fluid Mechanics," Pergamon Press, Ltd., London; Addison-Wesley Publishing Company, Inc., Reading, Mass.; 1959, p. 342.

IX. EXAMPLES OF VISCOUS AND CONDUCTING FLOWS

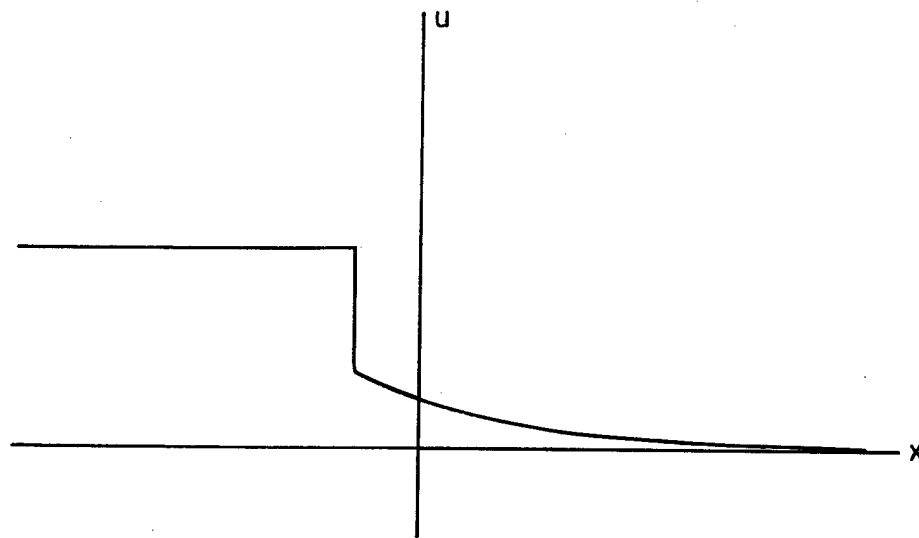

Sound Waves in a Viscous, Conducting Gas

Consider a gas whose state is perturbed only slightly from the uniform state in which $\rho = \rho_0$, $p = p_0$, $I = I_0$, and $u = 0$. The equations of the previous section can be linearized to a good degree of approximation.

$$\frac{\partial \rho}{\partial t} + \rho_0 \frac{\partial u}{\partial x} = 0$$

$$\rho_0 \frac{\partial u}{\partial t} = \sigma \rho_0 \frac{\partial^2 u}{\partial x^2} - \frac{\partial p}{\partial x}$$

$$\rho_0 \frac{\partial I}{\partial t} = -p_0 \frac{\partial u}{\partial x} + \rho_0 \zeta \frac{\partial^2 I}{\partial x^2}$$

Put $p \equiv (\gamma - 1)\rho I$ and define $\varphi \equiv \rho/\rho_0$, $\alpha \equiv I/I_0$.

Then

$$\frac{\partial \varphi}{\partial t} + \frac{\partial u}{\partial x} = 0$$

$$\frac{\partial u}{\partial t} + (\gamma - 1) I_0 \left[\frac{\partial(\alpha + \varphi)}{\partial x} \right] - \sigma \frac{\partial^2 u}{\partial x^2} = 0$$

SOUND WAVES IN A VISCOUS, CONDUCTING GAS

$$\frac{\partial \alpha}{\partial t} + (\gamma - 1) \frac{\partial u}{\partial x} - \zeta \frac{\partial^2 \alpha}{\partial x^2} = 0$$

We look for progressive wave solutions of the form

$$\alpha = A \exp[i(kx + \omega t)]$$

$$\varphi = B \exp[i(kx + \omega t)]$$

$$u = D \exp[i(kx + \omega t)]$$

and find that the condition for existence of such solutions is

$$\begin{vmatrix} 0 & \omega & k \\ ik & ik & \frac{i\omega + \sigma k^2}{(\gamma - 1) I_0} \\ (i\omega + \zeta k^2) & 0 & (\gamma - 1)ik \end{vmatrix} = 0$$

or

$$\gamma \omega k^2 - i\zeta k^4 + \frac{\omega}{(\gamma - 1) I_0} (i\omega + \sigma k^2)(i\omega + \zeta k^2) = 0$$

Consider now three special cases. If $\sigma = \zeta = 0$, then

$$\omega^2 = \gamma(\gamma - 1) k^2 I_0$$

The sound speed is given by

$$c = \frac{\text{Re } \omega}{k}$$

where Re means the real part. Thus the nonviscous, nonconducting limit gives the familiar formula of previous chapters.

In the case $\sigma = 0$, $\zeta \rightarrow \infty$, the sound speed (the "isothermal sound

IX. EXAMPLES OF VISCOUS AND CONDUCTING FLOWS

speed") is thus found to be

$$a \equiv c_{\text{isothermal}} = \sqrt{(\gamma - 1)I_0}$$

in confirmation of the speculation of the last section.

If $\sigma \rightarrow \infty$, then ω is purely imaginary and the sound speed is zero.

In the limit that σ and ζ are small, the equation for ω can be solved for the lowest order viscosity and conduction effects. The result is

$$\omega = k \sqrt{\gamma(\gamma - 1)I_0} + \frac{ik^2}{2\gamma} [(\gamma - 1)\zeta + \gamma\sigma]$$

neglecting quadratic and higher terms in ζ and σ . Thus to this order of approximation, the change in ω due to viscosity and heat conduction is purely imaginary; the sound speed is not affected. The correction term results in a damping of the sound waves by the factor

$$\exp \left\{ -\frac{k^2 t}{2\gamma} [(\gamma - 1)\zeta + \gamma\sigma] \right\}$$

For a sound wave in normal air of wave length 100 cm (so that $k = 2\pi/100 \text{ cm}^{-1}$) the damping time will thus be many hundreds of seconds, during which time the signal will have gone many miles. The viscous damping is in that case negligible compared with that from inverse-square attenuation.

Neglect of the higher-order terms (which affect sound speed) is justified provided that

$$k \sigma \ll c_0$$

VERY LARGE CONDUCTIVITY

where c_0 is the unperturbed sound speed. For normal air, only very short wave length signals are affected, with negligible change noticed for wave lengths significantly greater than 10^{-4} cm.

Very Large Conductivity

If a fluid is very hot, then its dynamics may be affected appreciably by the presence of radiation. At sufficiently high temperatures, the fluid may be effectively completely transparent and in continuous local thermodynamic equilibrium with the radiation field. The temperature is then the same everywhere and radiation pressure gradients vanish. The equations of mass and momentum conservation are as before, but the equation of state becomes a relation between pressure and density only. The energy equation is therefore no longer needed in a study of the fluid dynamics and is useful only for determining the radiation energy flux necessary to maintain the isothermal state. We may thus write

$$\begin{aligned}\frac{\partial \rho}{\partial t} + \nabla \cdot (\rho \vec{u}) &= 0 \\ \rho \frac{\partial \vec{u}}{\partial t} + \rho (\vec{u} \cdot \nabla) \vec{u} + a^2 \nabla \rho &= 0\end{aligned}$$

where

$$a^2 \equiv \left(\frac{\partial p}{\partial \rho} \right)_T \quad (27)$$

in which derivative the temperature is held constant. The quantity a , which has the dimensions of velocity, is the isothermal sound speed. It is a function of density, and may depend explicitly on time, through

IX. EXAMPLES OF VISCOUS AND CONDUCTING FLOWS

variations of temperature with time.

For a truly-one-dimensional polytropic gas,

$$a = \sqrt{(\gamma - 1) I}$$

$$\frac{\partial u}{\partial t} + u \frac{\partial u}{\partial x} + a \frac{\partial \sigma}{\partial x} = 0 \quad (28)$$

$$\frac{\partial \sigma}{\partial t} + u \frac{\partial \sigma}{\partial x} + a \frac{\partial u}{\partial x} = 0$$

where [see III-(2)]

$$\sigma \equiv a \ln \frac{\rho}{\rho_0} \quad (29)$$

and ρ_0 is an arbitrary constant with the dimension of density.

Linearization of (28) leads to the wave equation, with a propagation speed of a for low-amplitude signals, thus justifying again the equation for isothermal sound speed. The linearization can be accomplished by dropping the terms with u undifferentiated, or by the following procedure. In Lagrangian coordinates, (28) can be written

$$\frac{\partial u}{\partial t} + a e^{\sigma/a} \frac{\partial \sigma}{\partial x_0} = 0$$

$$\frac{\partial \sigma}{\partial t} + a e^{\sigma/a} \frac{\partial u}{\partial x_0} = 0$$

These can be rearranged to give the following exact equation for σ :

$$\frac{\partial^2 e^{-\sigma/a}}{\partial t^2} + a^2 \frac{\partial^2 e^{\sigma/a}}{\partial x_0^2} = 0 \quad (30)$$

VERY LARGE CONDUCTIVITY

To linearize, expand the exponentials in power series, keeping only up through the first order terms; the result is again the simple wave equation. An approximation method can be developed based on retention of successively higher terms in the expansion. Alternately, with $\varphi \equiv e^{\sigma/a} \equiv \rho/\rho_0$, the exact equation can be written

$$\varphi \frac{\partial^2 \varphi}{\partial t^2} - 2 \left(\frac{\partial \varphi}{\partial t} \right)^2 - a^2 \varphi^3 \frac{\partial^2 \varphi}{\partial x_0^2} = 0$$

We shall now demonstrate a few simple properties of the isothermal polytropic gas, particularly where these properties differ qualitatively from those of the corresponding nonconducting gas. We first observe that there is a formal correspondence between the isothermal equations and the isentropic equations. If in the latter we let $\gamma \rightarrow 1$, then p is proportional to ρ and the mass and momentum equations have the same essential form as the isothermal equations. Thus it is possible to derive some of the isothermal relations from previous results. In many cases, however, it is simpler to work with the isothermal equations themselves.

Structure of the isothermal rarefaction is determined from the similarity solution in which u and σ depend on $y \equiv x/t$ only. The equations become

$$(u - y) \frac{du}{dy} + a \frac{d\sigma}{dy} = 0$$

$$(u - y) \frac{d\sigma}{dy} + a \frac{du}{dy} = 0$$

IX. EXAMPLES OF VISCOUS AND CONDUCTING FLOWS

The boundary conditions we choose are

$$\begin{aligned} \text{at } x = -\infty, \quad \rho &= \rho_0 \text{ (so that } \sigma = 0), \text{ and } u = 0 \\ \text{at } x = +\infty, \quad \rho &< \rho_0 \text{ (so that } \sigma < 0), \text{ and } u = u_\infty > 0 \end{aligned}$$

The corresponding solution within the rarefaction zone is

$$\begin{aligned} u &= a + y \\ \sigma &= -a - y \end{aligned}$$

Thus the density profile in the rarefaction is

$$\rho = \rho_0 e^{(-1-x/at)}$$

At $x = -at$, $\rho = \rho_0$. No matter how large may be u_∞ , the density will not drop to zero. Thus cavitation cannot occur in such an isothermal rarefaction.

The shock relations can be derived in the same manner as in Chapter IV. For a steady shock moving with velocity v into an isothermal gas at rest, the following relations are summarized

$$\left. \begin{aligned} u_- &= \frac{v^2 - a^2}{v} \\ \frac{\rho_-}{\rho_+} &= \left(\frac{v}{a}\right)^2 \end{aligned} \right\} \quad (31)$$

or

$$\left. \begin{aligned} v &= \frac{1}{2} \left(u_- + \sqrt{u_-^2 + 4a^2} \right) \\ \frac{\rho_-}{\rho_+} &= \frac{\sqrt{u_-^2 + 4a^2} + u_-}{\sqrt{u_-^2 + 4a^2} - u_-} \end{aligned} \right\} \quad (32)$$

Note that for $u_- \gg a$, then

$$\frac{\rho_-}{\rho_+} \approx \frac{u_-^2}{a^2}$$

and the compression across the shock can be arbitrarily high. [This is in contrast to the nonconducting case where the density ratio is bounded by the quantity $(\gamma + 1)/(\gamma - 1)$].

CHAPTER X

SOME SPECIAL PROBLEMS

There are certain fluid-dynamic problems for which complete, exact solutions have been obtained. Several of these are discussed in this chapter, because they illustrate well some of the methods of solution and because they pertain to common situations of interest. They are also useful for comparison with the results of approximation methods, for evaluation of their accuracy.

Problem 1. Flow Past a Wedge

Gas flowing past an infinite two-dimensional wedge of half angle α approaches a steady state configuration as time passes. If the incom-

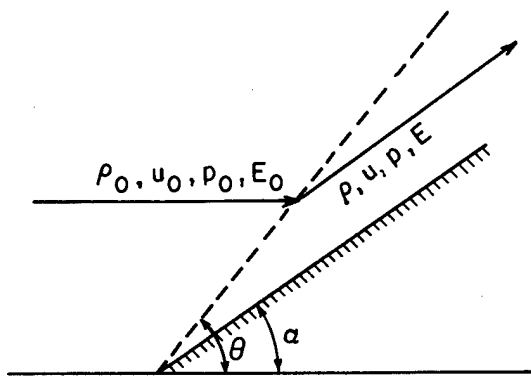

ing gas is moving sufficiently fast, then an attached shock (dotted line) is formed. Since there is no significant length to the system (the appearance of the configuration is independent of magnification), then the shock line must be straight.

PROBLEM 1. FLOW PAST A WEDGE

Furthermore, the trajectory of each element of fluid will be a pair of straight lines as shown; beyond the shock, the trajectory must be parallel to the side of the wedge. In the diagram, the solid line is the trajectory of a fluid element.

It is convenient to resolve the velocity on each side of the shock into components parallel and perpendicular to the shock. Then the relations across the shock can be formed in just the same way as

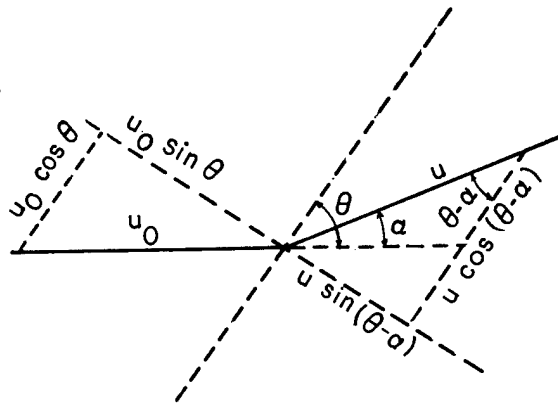

they were for the simple one-dimensional shock in Chapter IV. Let m be the mass per unit area per unit time crossing the shock.

$$m \equiv \rho_0 u_0 \sin \theta = \rho u \sin (\theta - \alpha) \quad (1)$$

To conserve tangential momentum,

$$m u_0 \cos \theta = m u \cos (\theta - \alpha) \quad (2)$$

To conserve normal momentum,

$$p_0 + m u_0 \sin \theta = p + m u \sin (\theta - \alpha) \quad (3)$$

To conserve energy,

$$m E_0 + p_0 u_0 \sin \theta = m E + p u \sin (\theta - \alpha) \quad (4)$$

These four relations, together with the equation of state, are sufficient to determine the shock angle, as well as the field variables behind the shock, all in terms of the known input field variables.

X. SOME SPECIAL PROBLEMS

Consider, for example, the case of a polytropic gas for which $E = p/[(\gamma - 1)\rho] + 1/2 u^2$. In terms of the incoming Mach number ($M \equiv$ ratio of u_0 to initial sound speed), one can show by straightforward manipulation that

$$\tan(\theta - \alpha) = \frac{2 + (\gamma - 1) M^2 \sin^2 \theta}{(\gamma + 1) M^2 \sin \theta \cos \theta} \quad (5)$$

For given values of M and α , θ can be found, and the other field variables obtained from

$$\rho = \rho_0 \frac{\tan \theta}{\tan(\theta - \alpha)} \quad (6)$$

$$u = u_0 \frac{\cos \theta}{\cos(\theta - \alpha)} \quad (7)$$

$$p = p_0 + \rho_0 u_0^2 \sin^2 \theta \left[1 - \frac{\tan(\theta - \alpha)}{\tan \theta} \right] \quad (8)$$

Note, from (5), that for infinite Mach number (incoming gas is cold),

$$\tan(\theta - \alpha) = \frac{\gamma - 1}{\gamma + 1} \tan \theta$$

so that

$$\rho = \rho_0 \frac{\gamma + 1}{\gamma - 1}$$

in agreement with (IV-25). In this infinite Mach number case, one can solve explicitly for θ

$$\tan \theta = \frac{1}{(\gamma - 1) \tan \alpha} \left[1 - \sqrt{1 - (\gamma^2 - 1) \tan^2 \alpha} \right]$$

This solution is real only if $\tan \alpha \leq \sqrt{1/(\gamma^2 - 1)}$. For greater angles,

PROBLEM 2. THE SHOCK TUBE

the shock is no longer attached to the wedge, and a different procedure is required to solve the problem.

If $\alpha = 0$ (there is just a point disturbance to the flow field), then from (5) $\sin \theta = 1/M$.

Convenient graphs and tables have been prepared by various authors to show numerical results for many situations.*

Problem 2. The Shock Tube

A one-dimensional hydrodynamic system is divided into two semi-infinite sections by a diaphragm.

Initially, there is gas at rest on both sides, all at the same temperature. To the left of the diaphragm, the gas is initially at a higher density and pressure, ρ_- and p_- , than on the right, ρ_+ and p_+ . On both sides the specific internal energy is I_0 .

At $t = 0$, the diaphragm is removed, and at any later time there is observed a shock, s , moving to the right; a contact discontinuity,

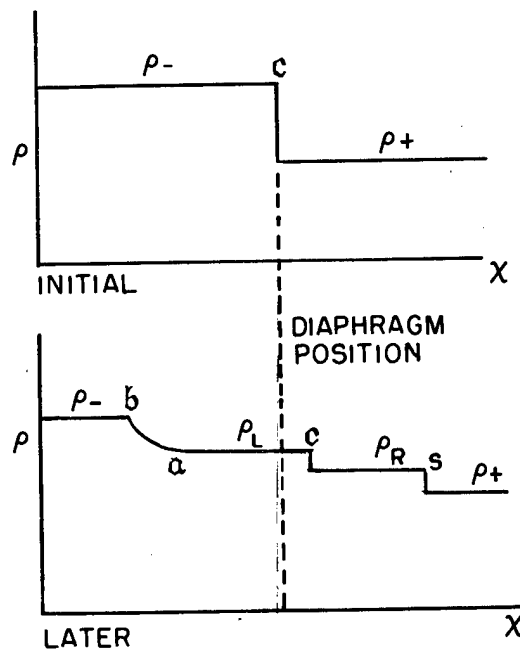

*See, for references, A. H. Shapiro, "The Dynamics and Thermodynamics of Compressible Fluid Flow," Volume 1, Art. 16.2, The Ronald Press Company, New York, 1953.

X. SOME SPECIAL PROBLEMS

c , moving to the right and a rarefaction wave, bounded by points a and b , moving to the left.

There is no significant length to the system (the appearance of the configuration at a later time is a magnification of an earlier appearance), so that each of the points moves with constant speed. The appearance to the left has already been discussed in Chapter III. The contact discontinuity in density is tentatively allowed, since similarity arguments cannot remove it. We shall see that if the density is assumed continuous at c , then the problem is overdetermined. The point at c behaves as if it were a piston pushing with uniform speed, and thus produces the kind of shock profile already discussed.

There are eight unknown quantities to be determined in the system: ρ_L, u_L, p_L, I_L and ρ_R, u_R, p_R, I_R . Through the equation of state, two of these, I_L and I_R , can be eliminated. Since no gas passes over the contact discontinuity, we must have $u_L = u_R$ (we call them both u_c). Also the pressure must be continuous across the contact discontinuity (otherwise, there would be an infinite acceleration); we put $p_L = p_R \equiv p_c$. We are thus left with four unknown quantities, ρ_L, ρ_R, u_c, p_c , for which four relations are needed. These are obtained as follows (we assume a polytropic gas): Across the shock, we use the relations of Chapter IV in the forms

$$(p_+ - p_c) \left(\frac{1}{\rho_+} - \frac{1}{\rho_R} \right) = -u_c^2 \quad (9)$$

and

PROBLEM 2. THE SHOCK TUBE

$$\frac{p_+ - p_c}{p_+ + p_c} = \gamma \frac{\rho_+ - \rho_R}{\rho_+ + \rho_R} \quad (10)$$

Across the rarefaction, entropy is conserved - see (II-4),

$$\frac{p_-}{p_c} = \left(\frac{\rho_-}{\rho_L} \right)^\gamma \quad (11)$$

Finally, a characteristic line $dx/dt = u + c$, goes across the rarefaction - see Chapter III - so that

$$\frac{2}{\gamma - 1} \sqrt{\frac{\gamma p_-}{\rho_-}} = u_c + \frac{2}{\gamma - 1} \sqrt{\frac{\gamma p_c}{\rho_L}} \quad (12)$$

We thus have the required four relations among the four unknowns. It is convenient to define

$$\left. \begin{aligned} \lambda &\equiv \frac{\rho_-}{\rho_+} = \frac{p_-}{p_+} \\ P &\equiv \frac{p_c}{p_+} \end{aligned} \right\} \quad (13)$$

so that λ is known from the initial configuration. Straightforward manipulation of (9) through (12) results in an equation determining P in terms of λ and γ :

$$\frac{(1 - P)^2}{\gamma(1 + P) - 1 + P} = \frac{2}{(\gamma - 1)^2} \left[1 - \left(\frac{P}{\lambda} \right)^{\frac{1}{2} \left(1 - \frac{1}{\gamma} \right)} \right]^2 \quad (14)$$

Some values of P for various values of λ and γ are shown in the following table.

X. SOME SPECIAL PROBLEMS

↓λ \ →γ	4/2	5/3	6/4	7/5	8/6
3	1.66859	1.68018	1.68789	1.69339	1.69751
4	1.88474	1.90514	1.91875	1.92846	1.93574
5	2.06428	2.09391	2.11371	2.12787	2.13849
8	2.47558	2.53295	2.57150	2.59917	2.61997
16	3.15841	3.28224	3.36650	3.42740	3.47343

With P determined, the rest of the unknown quantities are easily calculated:

$$\rho_R = \rho_+ \frac{\gamma(1+P) + (P-1)}{\gamma(1+P) - (P-1)} \quad (15)$$

$$\rho_L = \rho_+ (P\lambda^{\gamma-1})^{\frac{1}{2}} \quad (16)$$

$$I_R = I_0 \frac{P\rho_+}{\rho_R} \quad (17)$$

$$I_L = I_0 \frac{P\rho_+}{\rho_L} \quad (18)$$

$$u_c = 2\sqrt{\frac{\gamma I_0}{\gamma-1}} \left(1 - \sqrt{\frac{I_L}{I_0}} \right) \quad (19)$$

The shock moves with absolute speed

$$v_s = \frac{u_c \rho_R}{\rho_R - \rho_+} \quad (20)$$

The point c moves, of course, with absolute speed u_c , while the points a and b move with sound speed relative to the gas, or with absolute speeds

PROBLEM 3. SHOCK HITTING A DENSITY DISCONTINUITY

$$v_a = u_c - \sqrt{\gamma(\gamma - 1) I_L} \quad (21)$$

$$v_b = -\sqrt{\gamma(\gamma - 1) I_o} \quad (22)$$

Problem 3. Shock Hitting a Density Discontinuity

In the simplest form of this problem, a one-dimensional, steady-state shock passes through a uniform polytropic gas which is cold and at rest. At some point, it strikes a discontinuity in material, beyond which there is another (different) uniform polytropic gas which also initially is cold and at rest. We shall tentatively assume that a rarefaction is reflected back. The condition under which this is the case

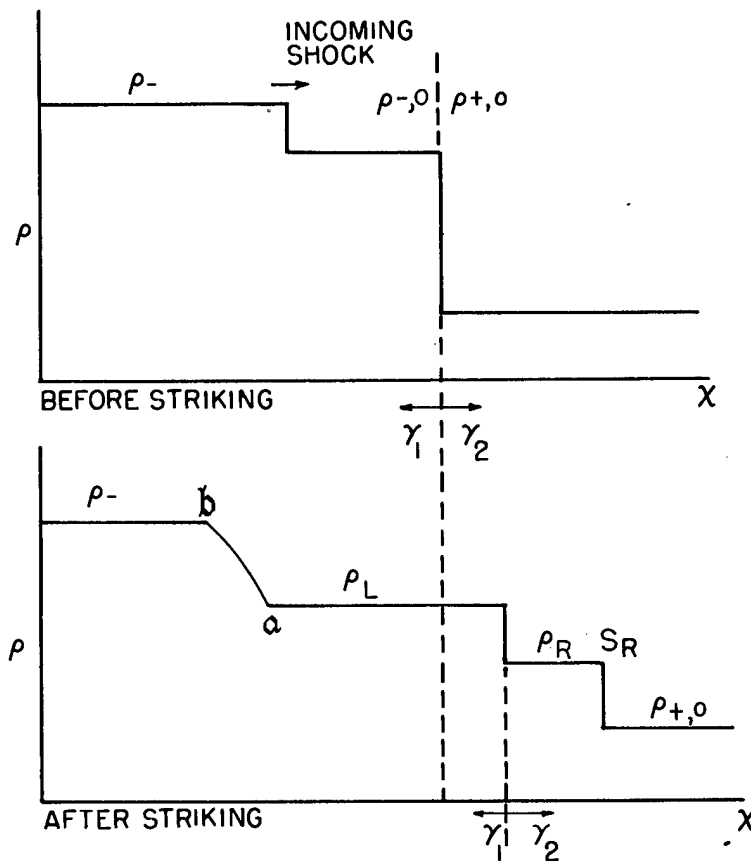

X. SOME SPECIAL PROBLEMS

will follow from the analysis. In any case a shock will be transmitted into the material to the right.

The incoming shock is characterized by the infinite shock relations (IV-25):

$$\left. \begin{aligned} \rho_- &= \rho_{-,0} \left(\frac{\gamma_1 + 1}{\gamma_1 - 1} \right) \\ v_{s_-} &= \left(\frac{\gamma_1 + 1}{2} \right) u_- \\ I_- &= \frac{1}{2} u_-^2 \\ p_- &= \left(\frac{\gamma - 1}{2} \right) \rho_- u_-^2 \end{aligned} \right\} \quad (23)$$

The analysis follows closely that for the shock tube problem. The same quantities (with the same symbols) are unknown, and the four equations determining them are [arising as in (9) to (12)]:

$$\left. \begin{aligned} -p_c \left(\frac{1}{\rho_+} - \frac{1}{\rho_R} \right) &= -u_c^2 \\ \frac{\rho_R}{\rho_+} &= \frac{\gamma_2 + 1}{\gamma_2 - 1} \\ \frac{\rho_-}{\rho_c} &= \left(\frac{\rho_-}{\rho_c} \right)^\gamma \\ u_- + \frac{2}{\gamma_1 - 1} \sqrt{\frac{\gamma_1 p_-}{\rho_-}} &= u_c + \frac{2}{\gamma_1 - 1} \sqrt{\frac{\gamma_1 p_c}{\rho_L}} \end{aligned} \right\} \quad (24)$$

PROBLEM 3. SHOCK HITTING A DENSITY DISCONTINUITY

Define, for convenience

$$A \equiv \frac{\rho_{-,0} (\gamma_1 + 1)}{\rho_{+,0} (\gamma_2 + 1)} \quad (25)$$

$$P \equiv \frac{p_-}{p_c} \quad (26)$$

where A is known from the input conditions and P is to be determined.

Some manipulation shows that P is determined in terms of A and γ_1 by

$$\frac{2A}{\gamma_1 - 1} = \left\{ \frac{2\sqrt{\gamma_1}}{\gamma_1 - 1} \left[\sqrt{P} - \left(\sqrt{P}\right)^{1/\gamma_1} \right] + \sqrt{\frac{2P}{\gamma_1 - 1}} \right\}^2 \quad (27)$$

If, now, a rarefaction is indeed reflected, then $P > 1$ is required.

This corresponds to $A > 1$, which, therefore, is the required condition for a reflected rarefaction. Some values of P for various values of A and γ_1 are given below.

A \ γ_1	4/2	5/3	6/4	7/5	8/6
2	1.44587	1.47088	1.49165	1.50933	1.52477
4	2.18104	2.24690	2.30289	2.35154	2.39453
8	3.42041	3.55215	3.66725	3.76930	3.86089
12	4.52404	4.71103	4.87742	5.02684	5.16226

With P known, the other unknown quantities in the system can be calculated:

X. SOME SPECIAL PROBLEMS

$$\left. \begin{aligned}
 \rho_L &= \rho_-(P)^{-1/\gamma_1} \\
 \rho_R &= \rho_{+,0} \left(\frac{\gamma_2 + 1}{\gamma_2 - 1} \right) \\
 u_c &= u_- \sqrt{\frac{A}{P}} \\
 v(\text{right shock}) &= u_c \left(\frac{\gamma_2 + 1}{2} \right)
 \end{aligned} \right\} \quad (28)$$

The points a and b move to the left with sound speed relative to the material. One may notice, however, that the point b moves to the right relative to the rest frame if $\gamma_1 < 2$.

Notice that if $\rho_{+,0} = 0$ (the shock hits a free surface), then one can derive the fact that the free surface will move with the sum of the material speed in the shock plus the escape speed of the shocked material (as derived in Chapter III). This is proved as follows. As $\rho_{+,0} \rightarrow 0$, $A \rightarrow \infty$ and $P \rightarrow \infty$. From (27), we see that

$$\frac{A}{P} \rightarrow \left(\sqrt{\frac{2\gamma_1}{\gamma_1 - 1}} + 1 \right)^2$$

so that, from (28),

$$u_c \rightarrow u_- \left(1 + \sqrt{\frac{2\gamma_1}{\gamma_1 - 1}} \right)$$

With (IV-25), this becomes

$$u_c \rightarrow u_- + \frac{2c_-}{\gamma_1 - 1}$$

with the second term being just the escape speed (III-7).

PROBLEM 3. SHOCK HITTING A DENSITY DISCONTINUITY

A second case must also be considered, that in which a shock is reflected back from the discontinuity. It is expected that this will occur if $A < 1$. We shall indeed see the general result

$$\frac{\rho_{-,0} (\gamma_1 + 1)}{\rho_{+,0} (\gamma_2 + 1)} \begin{cases} > 1 \text{ rarefaction reflected} \\ < 1 \text{ shock reflected} \end{cases} \quad (29)$$

In the reflected-shock case, the four conditions relating the four unknowns are all derived from shock relations:

$$\frac{\rho_R}{\rho_{+,0}} = \frac{\gamma_2 + 1}{\gamma_2 - 1} \quad (30)$$

$$\frac{2 p_c}{\rho_{+,0}} = (\gamma_2 + 1) u_c^2 \quad (31)$$

$$\frac{p_- - p_c}{p_- + p_c} = \gamma_1 \frac{\rho_- - \rho_L}{\rho_- + \rho_L} \quad (32)$$

$$(p_c - p_-) \left(\frac{1}{\rho_2} - \frac{1}{\rho_-} \right) = - (u_c - u_-)^2 \quad (33)$$

The relation between A and P can be derived in similar fashion:

$$\sqrt{A} = \sqrt{P} - (1 - P) \sqrt{\frac{\gamma_1 - 1}{\gamma_1 P + \gamma_1 - P + 1}} \quad (34)$$

Since $P < 1$ is required for the shock reflection, we see that this means $A < 1$, completing the proof of (29). Some values of P for various values of A and γ_1 are given below.

X. SOME SPECIAL PROBLEMS

A \ γ_1	4/2	5/3	6/4	7/5	8/6
0.2	0.505768	0.480057	0.460067	0.443920	0.430509
0.4	0.658085	0.639622	0.625000	0.613003	0.602905
0.6	0.784182	0.772321	0.762822	0.754954	0.748275
0.8	0.896522	0.890783	0.886148	0.882281	0.878982

With P known, the other quantities in the system can be calculated

$$\left. \begin{aligned}
 \rho_L &= \rho_- \left[\frac{\gamma_1(1+P) + (1-P)}{\gamma_1(1+P) - (1-P)} \right] \\
 \rho_R &= \rho_{+,o} \left(\frac{\gamma_2 + 1}{\gamma_2 - 1} \right) \\
 u_c &= u_- \sqrt{\frac{A}{P}} \\
 v_{sR} &= u_c \left(\frac{\gamma_2 + 1}{2} \right) \\
 v_{sL} \text{ (absolute)} &= \frac{(\rho_- u_-) - (\rho_+ u_c)}{\rho_- - \rho_L}
 \end{aligned} \right\} \quad (35)$$

In the special case that $\rho_{+,o} = \infty$ (the shock strikes a rigid wall and reflects back), then $A = 0$ and $P = (\gamma_1 - 1)/(3\gamma_1 - 1)$. In this case,

$$\left. \begin{aligned}
 \rho_L &= \rho_- \left(\frac{\gamma_1}{\gamma_1 - 1} \right) \\
 u_c &= 0 \\
 v_{sL} \text{ (absolute)} &= -(\gamma_1 - 1) u_- \\
 I_L &= \left(\frac{3\gamma_1 - 1}{\gamma_1} \right) I_-
 \end{aligned} \right\} \quad (36)$$

PROBLEM 3. SHOCK HITTING A DENSITY DISCONTINUITY

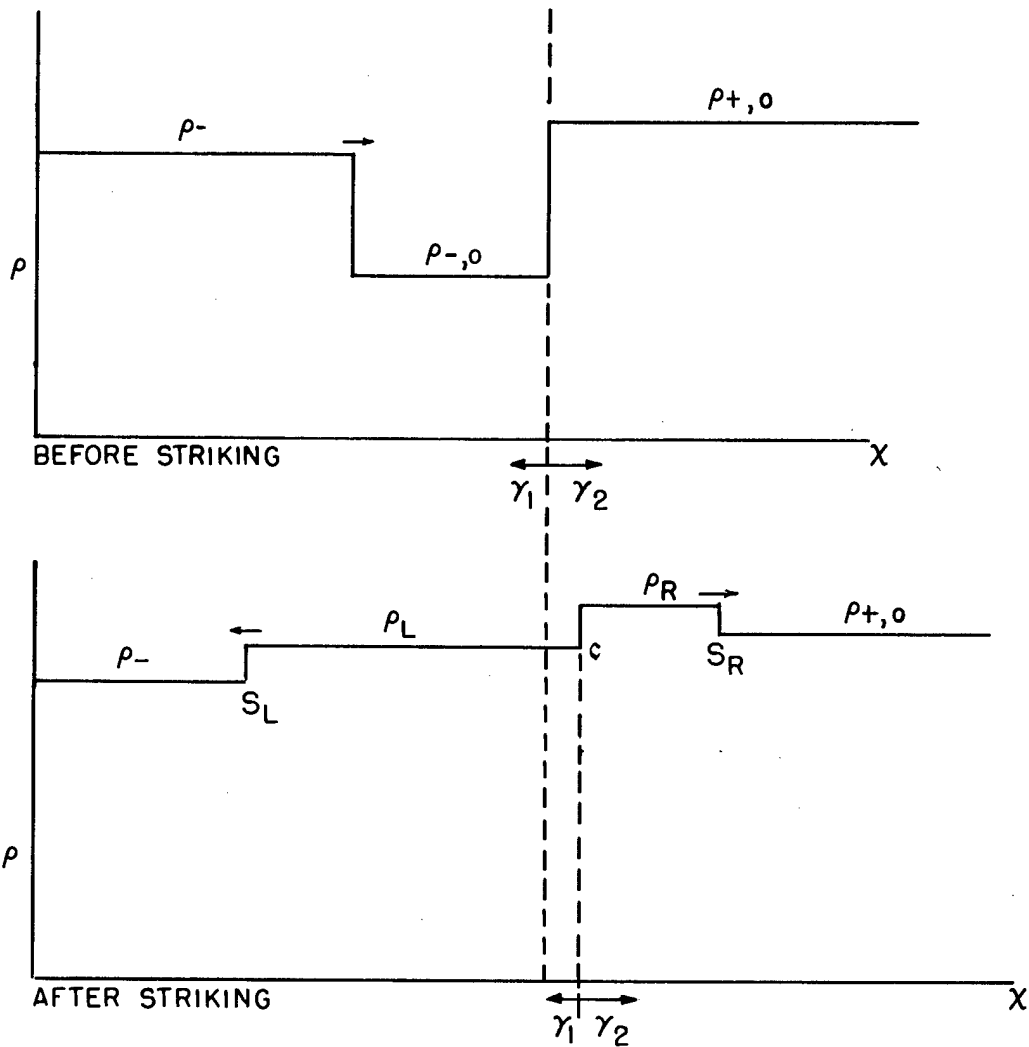

Another question of interest is: How can one use such a reflective system to produce a stationary shock for study? This can be accomplished if the reflected shock at s_L moves with zero speed. According to (35), the condition for this is $\rho_- u_- = \rho_L u_c$. The result of some algebraic manipulation shows that this can be realized provided

$$A \equiv \frac{\rho_{-,0} (\gamma_1 + 1)}{\rho_{+,0} (\gamma_2 + 1)} = \frac{(\gamma_1 - 1)^3}{3 - \gamma_1} \quad (37)$$

X. SOME SPECIAL PROBLEMS

Problem 4. The Reactive Shock or Detonation

We assume that the conditions on each side of the detonation front are uniform, and that the detonation itself takes place instantaneously along a moving discontinuity.

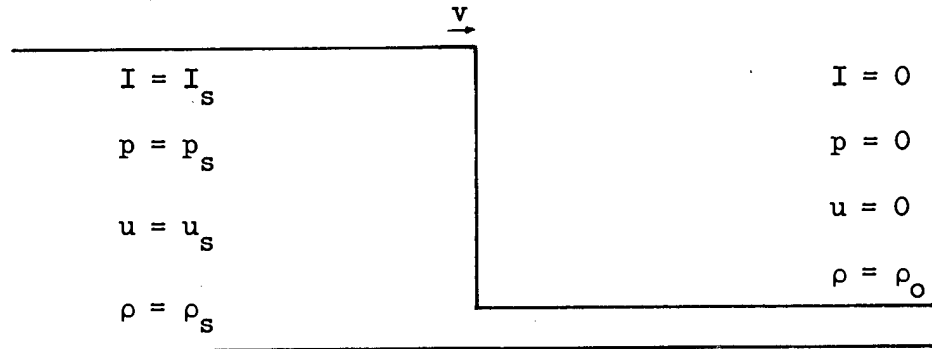

Actually, the total internal energy per unit mass on the right side is not zero, but K , the chemical energy per unit mass. With this change, the shock relations [Equations (14), (15), (16) of Chapter IV] are directly applicable

$$v(\rho_s - \rho_o) = \rho_s u_s$$

$$p_s(\rho_s - \rho_o) = \rho_o \rho_s u_s^2$$

$$I_s - K = \frac{p_s}{2} \left(\frac{\rho_s - \rho_o}{\rho_s \rho_o} \right)$$

It is assumed that u_s is known; it is the velocity of the driving piston. We assume further that the detonation products can be represented by a polytropic state equation; experiments show that this is a reasonable assumption for many explosives.

These equations can be solved as follows [we have put

PROBLEM 4. THE REACTIVE SHOCK OR DETONATION

$$p_s = (\gamma - 1) \rho_s I_s]:$$

$$\frac{\rho_s}{\rho_0} = \left[\frac{(2K/u_s^2) + (\gamma + 1)/\gamma - 1}{2K/u_s^2 + 1} \right] \quad (38)$$

$$I_s = K + \frac{1}{2} u_s^2 \quad (39)$$

$$v = (\gamma - 1) \frac{K}{u_s} + \frac{(\gamma + 1)}{2} u_s \quad (40)$$

In the limit that $K \rightarrow 0$, these reduce to the familiar relations for an infinite shock. With $K > 0$, the detonation front moves faster than the infinite shock, and the density behind the front is correspondingly less.

We note that the results predict that as $u_s \rightarrow 0$ (for K fixed) the detonation speed becomes infinite. We thus expect that the results are in error for small piston speeds. Indeed, there is another reason for believing this. We note that the sound speed just behind the detonation is

$$c_s = \sqrt{\gamma(\gamma - 1)(K + \frac{1}{2} u_s^2)}$$

For sufficiently high piston velocities, $u_s + c_s$ is thus greater than v ; that is, signals from the piston can overtake the detonation front from behind and thus influence it. For small piston velocities the above model would predict $u_s + c_s < v$ and no signal could overtake the front from behind. Thus, for piston speeds less than $v - c_s$, no signal from behind the front can catch up with it, and the detonation process must

X. SOME SPECIAL PROBLEMS

proceed in a manner independent of the motion of the piston. We thus conclude that for an underdriven detonation, the front must move exactly as for a critically driven detonation; that is, one for which $c_s + u_s = v$. (This condition, which determines the motion of an under-driven detonation, is called the Chapman-Jouguet condition.) Substitution of the conditions for an over-driven detonation into the Chapman-Jouguet relation allows derivation of the following

$$v = \sqrt{2(\gamma^2 - 1) K} \quad (41)$$

$$u_s = \frac{v}{\gamma + 1} \quad (42)$$

$$p_s = 2(\gamma - 1) \rho_o K \quad (43)$$

$$I_s = \frac{2\gamma}{\gamma + 1} K \quad (44)$$

$$\rho_s = \frac{\gamma + 1}{\gamma} \rho_o \quad (45)$$

Just as for an infinite shock, the compression depends on γ only.

Determination of the profile behind an underdriven detonation can be made by means of the similarity method of Chapter V. We outline the procedure briefly. The equations

$$\frac{\partial \rho}{\partial t} + \frac{\partial \rho u}{\partial x} = 0$$

$$\rho \frac{\partial u}{\partial t} + \rho u \frac{\partial u}{\partial x} = - \frac{\partial p}{\partial x}$$

$$p = A\rho^\gamma$$

are applicable wherein A is a constant determined by the value of K.

PROBLEM 4. THE REACTIVE SHOCK OR DETONATION

The substitution $y = x/t$ and the assumption of dependence upon y only lead to

$$-y \frac{dp}{dy} + \frac{d\rho u}{dy} = 0$$

$$\rho(u - y) \frac{du}{dy} = - \frac{dp}{dy}$$

$$p = A\rho^\gamma$$

If these are to represent a detonation, then it is necessary that the boundary conditions be satisfied:

$$\text{at } y = v \left(\equiv \sqrt{2(\gamma^2 - 1) K} \right)$$

$$\rho = \frac{\gamma + 1}{\gamma} \rho_0$$

$$u = \frac{v}{\gamma + 1}$$

$$p = 2(\gamma - 1) \rho_0 K$$

$$I = \frac{2\gamma}{\gamma + 1} K$$

It thus is necessary that the value of A (which determines the amount of entropy behind the detonation) be given by

$$A = 2(\gamma - 1) \left(\frac{\gamma}{\gamma + 1} \right)^\gamma \rho_0^{1-\gamma} K$$

The solution can be carried through, and the boundary conditions indeed satisfied; the result is

X. SOME SPECIAL PROBLEMS

$$u = \frac{1}{\gamma + 1} \left(\frac{2x}{t} - v \right)$$

$$\rho = \frac{\gamma + 1}{\gamma} \rho_0 \left[\frac{(\gamma - 1) \frac{x}{t} + v}{\gamma v} \right]^{\frac{2}{\gamma - 1}}$$

The solution continues back to the point where $u = u_p$, the piston velocity. If $\rho = 0$ at the piston (so that the detonation takes place against a vacuum) then the free surface of the gas moves such that

$$\frac{x}{t} = - \frac{v}{\gamma - 1}$$

If the detonation takes place against a rigid wall, so that $u_p = 0$, then the velocity profile at some time after $t = 0$ is

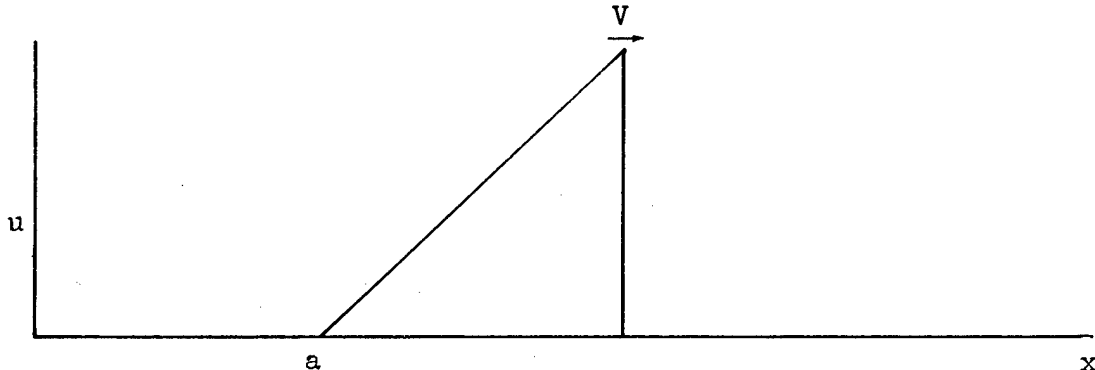

The point at which the velocity drops to zero is $x = a$. We see from the similarity solution that $a = \frac{1}{2} vt$. What is the total displacement of material caused by the passing over of such a detonation wave? This is determined by solving the differential equation:

$$\frac{dx}{dt} = u(x,t) = \frac{1}{\gamma + 1} \left(\frac{2x}{t} - v \right) \quad \text{for } \frac{vt}{2} \leq x \leq vt$$

$$= 0 \quad \text{otherwise}$$

PROBLEM 5. STEADY FLOW AROUND A SHARP CORNER

This has the solution

$$x = \frac{\gamma x_0}{\gamma - 1} \left(\frac{vt}{x_0} \right)^{\frac{2}{\gamma+1}} - \frac{vt}{\gamma - 1}$$

wherein has been put the boundary condition $x = x_0$ at $t = x_0/v$. When the wave has just passed by a particle, $x = \frac{1}{2} vt$, so that the final x of the particle is given by

$$x = \frac{\gamma x_0}{\gamma - 1} \left(\frac{2x}{x_0} \right)^{\frac{2}{\gamma+1}} - \frac{2x}{\gamma - 1}$$

or

$$\frac{x}{x_0} = \left[\frac{\gamma}{\gamma + 1} (2)^{\frac{2}{\gamma+1}} \right]^{\frac{\gamma+1}{\gamma-1}} \quad (46)$$

A graph of this result is shown as follows:

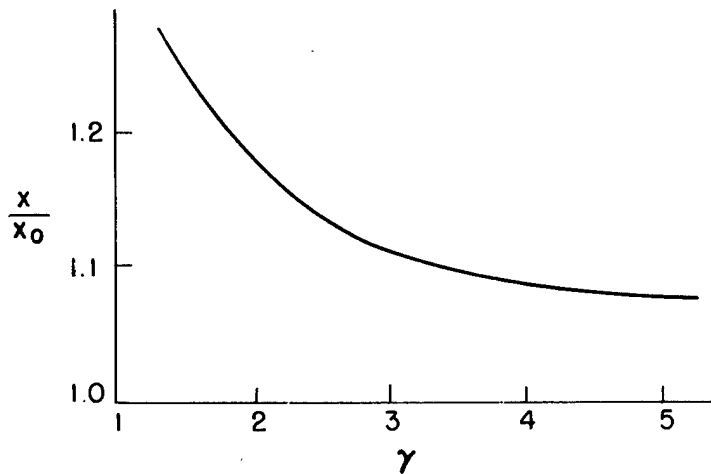

Problem 5. Steady Flow Around a Sharp Corner

A nonviscous, nonconducting, semi-infinite polytropic gas flowing parallel to a flat surface approaches a corner in the surface. If the

X. SOME SPECIAL PROBLEMS

surface bends into the gas flow, then the wedge theory (Problem 1) may be applicable. If the surface bends away, then a steady expanding flow may occur. (In both cases, the gas speed must be at least that of sound for a steady state to be present.) The latter flow, which concerns us here, is often called Prandtl-Meyer flow.

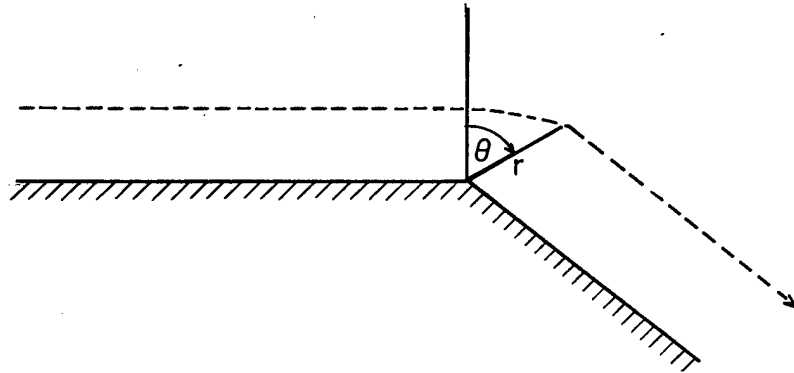

We choose cylindrical coordinates with origin at the corner; u and v are the components of velocity in the r and θ directions, respectively, and the equations are

$$\frac{\partial \rho}{\partial t} + \frac{1}{r} \frac{\partial \rho u r}{\partial r} + \frac{1}{r} \frac{\partial \rho v}{\partial \theta} = 0$$

$$\rho \frac{\partial u}{\partial t} + \rho \left(u \frac{\partial u}{\partial r} + \frac{v}{r} \frac{\partial u}{\partial \theta} \right) - \frac{\rho v^2}{r} + c^2 \frac{\partial \rho}{\partial r} = 0$$

$$\rho \frac{\partial v}{\partial t} + \rho \left(u \frac{\partial v}{\partial r} + \frac{v}{r} \frac{\partial v}{\partial \theta} \right) + \frac{\rho u v}{r} + \frac{c^2}{r} \frac{\partial \rho}{\partial \theta} = 0$$

$$c^2 = \gamma A \rho^{\gamma-1}$$

where A is a fixed constant related to the entropy of the gas — see (II-4). In steady-state flow, the time derivatives vanish. Also, since there is no length scale to the system, its appearance must be

PROBLEM 5. STEADY FLOW AROUND A SHARP CORNER

independent of magnification; that is, u , v and ρ must be independent of r .

With these conditions, the equations simplify considerably:

$$\rho \left(u + \frac{dv}{d\theta} \right) + v \frac{d\rho}{d\theta} = 0$$

$$v - \frac{du}{d\theta} = 0$$

$$\rho v \left(u + \frac{dv}{d\theta} \right) + c^2 \frac{d\rho}{d\theta} = 0$$

From the first and third of these,

$$\left(v^2 - c^2 \right) \frac{d\rho}{d\theta} = 0$$

Either $v \equiv c$, or ρ is identically constant. The latter alternative leads to the trivial solution of flow with no corner at all, parallel to the initial boundary. It is applicable up to the point at which $v = c$. In the subsequent flow, ρ then changes and $v \equiv c$ persists.

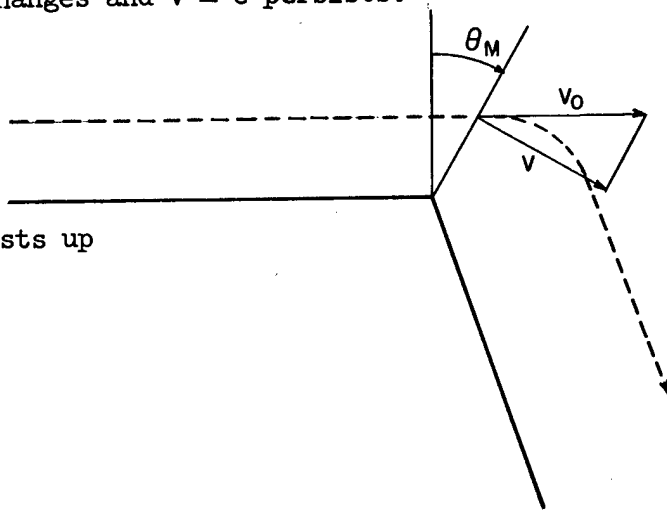

Thus, the original flow persists up to the angle, θ_M , such that

$$v = v_0 \cos \theta_M = c_0$$

X. SOME SPECIAL PROBLEMS

or

$$\theta_M = \cos^{-1} \left(\frac{c_0}{v_0} \right) \quad (47)$$

This is the angle of the "Mach line" from the corner. Beyond that angle, the gas begins to turn.

With $v \equiv c$, the equations become

$$\rho u + \frac{d\rho c}{d\theta} = 0$$

$$c - \frac{du}{d\theta} = 0$$

Now

$$\frac{d\rho c}{d\theta} \equiv b^2 \rho \frac{dc}{d\theta}$$

where we have introduced the abbreviation

$$b^2 \equiv \frac{\gamma + 1}{\gamma - 1}$$

Thus

$$u + b^2 \frac{dc}{d\theta} = 0$$

$$c - \frac{du}{d\theta} = 0$$

These have the solution

$$u = bA \sin \frac{\theta}{b} + bB \cos \frac{\theta}{b} \quad (48)$$

$$c = A \cos \frac{\theta}{b} - B \sin \frac{\theta}{b}$$

where A and B are constants of integration. The general boundary conditions are

$$\text{At } \theta = \theta_M, \quad v = c = c_0, \quad u = v_0 \sin \theta_M \quad (49)$$

PROBLEM 5. STEADY FLOW AROUND A SHARP CORNER

We look first, however, at the case $\theta_M = 0$ (i.e., $v_0 = c_0$). For this simpler case, the solution becomes

$$\left. \begin{aligned} u &= b c_0 \sin \frac{\theta}{b} \\ v &= c = c_0 \cos \frac{\theta}{b} \end{aligned} \right\} \quad (50)$$

How does the radial distance to a stream line vary with angle? From

$$\frac{dr}{dt} = u$$

$$\frac{d\theta}{dt} = \frac{v}{r}$$

we derive

$$\frac{dr}{d\theta} = \frac{ur}{v}$$

For the solution (50), this can be integrated to give

$$r = r_0 \left(\cos \frac{\theta}{b} \right)^{-b^2} \quad (51)$$

Note that the sound speed, and thus the density, drops to zero at $\theta = b\pi/2$; the gas will turn through no greater angle than that. One can show easily that the angular deflection of the stream line from horizontal, α , is given by

$$\alpha = \theta - \frac{\pi}{2} + \tan^{-1} \left(\frac{1}{b} \cot \frac{\theta}{b} \right) \quad (52)$$

For the more general boundary conditions, (49), analogous formulas may be derived. Alternately, the supersonic input flow can be assumed to

X. SOME SPECIAL PROBLEMS

have turned from sonic, through some angle θ_0 , and subsequent turning measured from the radius vector at $-\theta_0$. To accomplish this it is useful to express θ as a function of local Mach number M_1 which is defined as the ratio of the gas speed to the sound speed:

$$M \equiv \sqrt{\frac{u^2 + v^2}{c^2}}$$

Combination of this with (50) leads to

$$\theta = b \tan^{-1} \sqrt{\frac{M^2 - 1}{b^2}} \quad (53)$$

Thus, if the incoming Mach number is M_0 , then

$$\theta_0 = b \tan^{-1} \sqrt{\frac{M_0^2 - 1}{b^2}} - \theta_M$$

In turn, one can find the fictitious sound speed from which this turn started, and the fictitious initial radius for any stream line, and continue the solution as if from the initial sonic flow. This alternative procedure is especially useful for situations for which tables have been provided for Prandtl-Meyer solutions turning from sonic.

Finally, for reference, we include the formula for α as a function of M , derived from (52) and (53):

$$\alpha = b \tan^{-1} \sqrt{\frac{M^2 - 1}{b^2}} - \tan^{-1} \sqrt{M^2 - 1} \quad (54)$$

PROBLEM 6. INSTABILITY OF INTERFACE BETWEEN FLUIDS

Problem 6. Instability of Interface Between Fluids

There are various examples of fluid motions in which the question of interface stability arises. If, for example, a heavy fluid is suspended over a lighter one in a downward gravitational field, any irregularity of the interface will increase in amplitude. The upper fluid will fall into the lower one in a set of narrow penetrating spikes, while the lower fluid will float up in round-topped bubbles. This is an example of "Taylor instability."

Another type, known as "Helmholtz instability" occurs along a slip plane between two fluids (or within one fluid). Any slight irregularity is amplified, resulting in mixing if there is no counter process. An example is seen in the formation of water waves from the wind; another is in the flapping of a flag.

These two types of instability are best known for incompressible fluids (that is, for fluids whose motions proceed at velocities very small compared with their sound speeds). When accelerations are great and velocities large, then effects of compressibility can become important. Taylor instability problems then refer to the effects of a compression wave, or shock, sweeping across an irregular interface.

We shall here discuss several types of surface instability, including mainly those for incompressible fluids because of their ease in solving and because of their qualitative applicability to some compressible-fluid situations.

X. SOME SPECIAL PROBLEMS

Taylor Instability, Fluid Incompressible

We consider the case of low amplitude interface motions. For an incompressible fluid, in which the density of an element remains forever constant, the mass equation in two-dimensional flow becomes — see I-(2)

$$\frac{\partial u}{\partial x} + \frac{\partial v}{\partial y} = 0 \quad (55)$$

in which u and v are the velocity components in the x and y directions, respectively. In addition, the momentum equation, with vertical acceleration only (positive upwards) breaks into the two components — see I-(33).

$$\rho \frac{\partial u}{\partial t} + \frac{\partial p}{\partial x} = 0 \quad (56)$$

$$\rho \frac{\partial v}{\partial t} + \frac{\partial p}{\partial y} - \rho g = 0 \quad (57)$$

in which we have dropped the transport term $(\vec{u} \cdot \nabla) \vec{u}$ because of the smallness of the velocities. (The various approximations employed in this section can be verified as applicable by carefully keeping higher order terms in the velocity components or in the perturbation amplitudes, and noting the smallness of their contributions in the ranges of magnitudes we are considering.)

Thus, we have three equations in three unknowns, u , v , and p . To solve them, we first note that (55) is satisfied if we can find a function, ϕ , such that

$$\left. \begin{aligned} u &= - \frac{\partial \phi}{\partial x} \\ v &= - \frac{\partial \phi}{\partial y} \end{aligned} \right\} \quad (58)$$

PROBLEM 6. INSTABILITY OF INTERFACE BETWEEN FLUIDS

and

$$\frac{\partial^2 \varphi}{\partial x^2} + \frac{\partial^2 \varphi}{\partial y^2} = 0 \quad (59)$$

The function, φ , is called a potential function. Furthermore, with these substitutions, (56) and (57) become

$$\frac{\partial}{\partial x} \left(p - \rho \frac{\partial \varphi}{\partial t} \right) = 0$$

$$\frac{\partial}{\partial y} \left(p - \rho \frac{\partial \varphi}{\partial t} - \rho g y \right) = 0$$

which two equations are consistent and lead to

$$p = p_0 + \rho \frac{\partial \varphi}{\partial t} + \rho g y$$

Now this is a two-fluid problem with a horizontal surface of separation. Let the surface of separation be denoted by the equation

$$y = A(t) \cos kx \quad (60)$$

We label the upper fluid with subscript 1, and the lower with subscript 2, and suppose that there is a potential function for each fluid, φ_1 and φ_2 . Likewise there is a pressure solution for each fluid

$$\left. \begin{aligned} p_1 &= p_{0,1} + \rho_1 g y + \rho_1 \frac{\partial \varphi_1}{\partial t} \\ p_2 &= p_{0,2} + \rho_2 g y + \rho_2 \frac{\partial \varphi_2}{\partial t} \end{aligned} \right\} \quad (61)$$

It may be verified that the following potential functions are solutions of (59):

X. SOME SPECIAL PROBLEMS

$$\left. \begin{aligned} \varphi_1 &= e^{-ky} f(t) \cos kx \\ \varphi_2 &= -e^{ky} f(t) \cos kx \end{aligned} \right\} \quad (62)$$

(We have not specified the boundary conditions used in finding the solution of (59); they are such that the fluid is at rest at $y = \pm \infty$ and that all features have the same periodicity in x as the initial interface between fluids.)

We may now obtain the solution in complete form by applying the matching conditions at the interface. These are:

1. The interface moves with the fluid velocity.
2. The pressure is continuous across the interface.

The first of these can be approximated in this low amplitude study by

$$v(y = 0) = \left(\frac{\partial y}{\partial t} \right)_{y=0}$$

which reduces to

$$\frac{dA}{dt} = f(t)$$

The second interface condition expresses the equality of the two pressures in (61) at $y = 0$. Thus

$$\begin{aligned} p_{0,1} + \rho_1 \left(g A \cos kx + \frac{df}{dt} \cos kx \right) \\ = p_{0,2} + \rho_2 \left(g A \cos kx - \frac{df}{dt} \cos kx \right) \end{aligned}$$

Now the low amplitude stage we are considering is supposed to be but a

PROBLEM 6. INSTABILITY OF INTERFACE BETWEEN FLUIDS

slight perturbation from complete equilibrium at zero amplitude, so that the zero-amplitude pressures must just balance, and the results of applying the two interface conditions all reduce to

$$\frac{d^2 A}{dt^2} = A \left[kg \left(\frac{\rho_2 - \rho_1}{\rho_2 + \rho_1} \right) \right] \quad (63)$$

Thus, with $g < 0$ (i.e., the acceleration pointing downward), then the coefficient of A on the right is positive when the upper fluid is the more dense — leading to exponentially increasing amplitude — and negative when the upper fluid is the less dense — leading to a time-wise oscillation of amplitude. The first case is that of Taylor instability.

Combined Helmholtz and Taylor Instabilities

Again we consider the case of low amplitude perturbations. The situation is as in (a) except that now the upper fluid moves to the right with velocity $u = U$ relative to the lower one (which can be considered at rest without loss of generality). The equations must be generalized somewhat, and we shall employ a slightly different technique for solving them.

The mass equation remains the same as before, (55), and we satisfy it again with upper and lower potential functions ϕ_1 and ϕ_2 . The momentum equations for the upper fluid, however, must retain the one component of transport relative to the rightward motion, so that the equations now are written

$$\left. \begin{aligned} \rho \frac{\partial u}{\partial t} + \rho U \frac{\partial u}{\partial x} + \frac{\partial p}{\partial x} &= 0 \\ \rho \frac{\partial v}{\partial t} + \rho U \frac{\partial v}{\partial x} + \frac{\partial p}{\partial y} - \rho g &= 0 \end{aligned} \right\} \quad (64)$$

X. SOME SPECIAL PROBLEMS

Thus the two pressure integrals, analogous to (61), become

$$\left. \begin{aligned} p_1 &= p_{o,1} + \rho_1 \left(gy + \frac{\partial \phi_1}{\partial t} + U \frac{\partial \phi_1}{\partial x} \right) \\ p_2 &= p_{o,2} + \rho_2 \left(gy + \frac{\partial \phi_2}{\partial t} \right) \end{aligned} \right\} \quad (65)$$

We now write the equation of the interface in the form

$$y = y_o e^{\omega t - ikx} \quad (66)$$

and take for the potential functions (which satisfy (59) and proper boundary conditions)

$$\left. \begin{aligned} \phi_1 &= \alpha y_o e^{-ky + \omega t - ikx} - Ux \\ \phi_2 &= \beta y_o e^{ky + \omega t - ikx} \end{aligned} \right\} \quad (67)$$

where α , β , and ω are constants to be determined, and k is the wave number of the interface disturbance. Again the same two interface conditions must apply, and there must also in this manner of treatment be an expression for continuity of vertical velocity across the interface.

Thus, for the upper fluid

$$v(y = 0) = \left(\frac{\partial y}{\partial t} + U \frac{\partial y}{\partial x} \right)_{y=0}$$

while for the lower fluid

$$v(y = 0) = \left(\frac{\partial y}{\partial t} \right)_{y=0}$$

These two conditions lead to the determination of α and β

PROBLEM 6. INSTABILITY OF INTERFACE BETWEEN FLUIDS

$$\alpha = \frac{\omega}{k} - i U$$

$$\beta = -\frac{\omega}{k}$$

The continuity-of-pressure condition shows that in complete equilibrium,

$$p_{o,1} - \rho_1 U^2 = p_{o,2}$$

and that in lowest order perturbation,

$$\rho_1 (g + \alpha\omega - i kU\alpha) = \rho_2 (g + \beta\omega)$$

which reduces, finally, to

$$\omega = \frac{ikU\rho_1}{\rho_1 + \rho_2} \pm k \sqrt{\frac{g}{k} \left(\frac{\rho_2 - \rho_1}{\rho_2 + \rho_1} \right) + \frac{U^2 \rho_2 \rho_1}{(\rho_2 + \rho_1)^2}} \quad (68)$$

With $U = 0$, the result is the same as before. With $U \neq 0$, there are two additional contributions. The first on the right of (68) expresses the mean translation velocity of the waves. The second, under the square root, expresses the Helmholtz instability effect. It is always positive, hence always contributes to giving ω a real part corresponding to exponential growth of the instability. Even in the case that $g = 0$ and $\rho_1 = \rho_2$, the instability remains, in which case

$$\omega = \frac{1}{2} kU(i \pm 1)$$

The results can be extended even further to include the effects

X. SOME SPECIAL PROBLEMS

of surface tension; rather than repeat the analysis,* we simply present the final equation for the exponential growth factor

$$\omega = \frac{ikU\rho_1}{\rho_1 + \rho_2} \pm k \sqrt{\frac{g}{k} \left(\frac{\rho_2 - \rho_1}{\rho_2 + \rho_1} \right) + \frac{U^2 \rho_2 \rho_1}{(\rho_2 + \rho_1)^2} - \frac{kT}{\rho_2 + \rho_1}} \quad (69)$$

in which T is the surface tension. It is seen, as could have been expected, that surface tension has a stabilizing effect. Likewise it can be seen that there is a most-unstable wave length, obtained by maximizing the second term on the right of (69) — provided the second term has a real maximum.

The effects of viscosity are much more difficult to include in full generality;** however, in some cases it is sufficiently accurate to write

$$\omega = \frac{ikU\rho_1}{\rho_1 + \rho_2} - vk^2 \pm k \sqrt{\frac{g}{k} \left(\frac{\rho_2 - \rho_1}{\rho_2 + \rho_1} \right) + \frac{U^2 \rho_2 \rho_1}{(\rho_2 + \rho_1)^2} - \frac{kT}{\rho_2 + \rho_1}} \quad (70)$$

where

$$v \equiv \frac{\mu_1 + \mu_2}{\rho_1 + \rho_2}$$

and μ_1, μ_2 are the coefficients of viscosity. Discussions of the validity of various approximation procedures have been given in the references mentioned above. Chandrasekhar and Hide both give in addition

* See, for example, Horace Lamb, "Hydrodynamics," Sixth Edition, Dover Publications, New York, 1932, Section 268, p. 461.

**Various treatments have been given by Bellman and Pennington, *Quart. Appl. Math.*, 12, 151, 1954; by S. Chandrasekhar, *Proc. Cambridge Phil. Soc.*, 51, 162, 1955; and by R. Hide, *Proc. Cambridge Phil. Soc.*, 51, 179, 1955.

PROBLEM 6. INSTABILITY OF INTERFACE BETWEEN FLUIDS

discussions of the effects of gradual density gradients, and later authors have solved various problems concerning stability of variable atmospheres.

At present there appears to exist no comprehensive discussion of the effects of diffusion on interface instability, although a qualitative argument can be given to show that the effects are likely to increase stability.

INDEX

- Accelerated viscous flow, 146
 Acceleration, 35
 Active degrees of freedom, 125
 Adiabatic, 82
 Adiabatic equation of state, 42
 Adiabatic heating, 41
 Aerodynamics, 7, 84
 Angular momentum, 49
 conservation of, 50
 Angular velocity, 44
 rate of change of, 46
 Atmosphere, equilibrium state of, 56
 sound in variable density of, 55

 Boltzmann equation, 137
 Boundary layer, thickness of, 141

 Chapman-Jouguet condition, 178
 Characteristic line, 59, 63
 Characteristic solution, 58, 89
 Characterization of fluid, 9, 15
 Chemical energy, 176
 Chemical reactions, 14
 Circulation, 47
 Coefficient, of heat conduction, 122
 of viscosity, 115, 118
 Cohesive fluids, 113
 Compression, maximum from shock, 80
 monotonic, 82
 by shock, 71
 Compression wave in viscous fluid, 148
 Conduction, coefficient of, 122
 of heat, 10, 12, 44
 rate of, 120

 Conservation, of angular momentum, 50
 of energy, 20, 37, 72, 123, 135, 136, 138
 laws of, 9
 of mass, 17, 72, 133, 135
 of momentum, 19, 36, 72, 118, 120, 134, 136, 138
 Conservative form of differential equations, 28, 29
 Constant-state region, 63
 Contact discontinuity, 71
 Contiguity, assumption of, 15
 Continuous fluid, approximation of, 11
 definition of, 14
 Coordinate, cylindrical 32
 Eulerian, 16
 Lagrangian, 16
 Coordinate systems, 31, 58
 Corner, flow around, 181
 Curved shock, 71
 Cylindrical coordinates, 32
 Cylindrical shell, expansion of, 33

 D_{ij} , 51
 Damping due to viscosity, 143
 Damping of sound waves, 156
 Decay of shock pulse, 91
 Decay rate, shock pressure, 102, 105
 Decomposition of velocity field, 51
 Deformation tensor, 52
 Degrees of freedom, 124
 active, 125
 Density, 16
 Derivative, along fluid motion, 21
 of volume integral, 26
 Detonation, underdriven, 178

Detonation theory, 176
 Diaphragm, fractured, 165
 Diatomic molecule, 124
 Differential equations, conservative
 form of, 28,29
 Diffusion, of molecules, 113
 of velocity, 115
 of viscous effect, 140
 Dilatation pressure, 119, 124
 Dilatative dissipation, 123
 Discontinuity, 71
 Dissipation, dilatative, 123
 Distribution function, molecular, 130
 Disturbance, small, 53
 Drag, viscous, 114

 Energy, 16
 conservation of, 20,37,72,123,135,
 136,138
 Energy conservation equation, 21,72,
 123,135,136,138
 Energy equation, general derivation
 of, 120
 internal, 16,40
 kinetic, 16
 potential, 38
 Energy equation, general derivation
 of, 120
 Entropy, 10,16,39,42,43
 change across shock, 81
 Equation, energy conservation, 21,
 72,123,135,136,138
 mass conservation, 17,72,133,135
 momentum conservation,
 20,72,118,120,134,136,138
 of state, 9,34
 of state, adiabatic, 42
 of state, molecular theory, 136
 of state, polytropic, 40,126,136
 Equations, Eulerian form, 10,28,30,
 41,84,87
 hydrodynamic, molecular derivation
 of, 133
 integral form, 30
 inverted, 106
 Lagrangian form, 10,21,26,29,30,93
 molecular derivation, 133
 nonlinearity of, 76

 Equations, two dimensional, 138
 viscous, conducting, 138
 viscous, two-dimensional, 138
 Equilibrium state of atmosphere, 56
 Escape speed, 61,67
 Eulerian coordinate, 16
 Eulerian form of equations, 10,28,
 30,41,84,87
 Expansion, into a vacuum, 111
 of cylindrical shell, 33
 Explosions, 7
 Explosive, 176
 External forces, 35

 Field, local decomposition of
 velocity, 51
 Field variables, 15,73
 First coefficient of viscosity, 115,118
 Flow, accelerated viscous, 146
 incompressible, 188
 Prandtl-Meyer, 182
 Fluid, characterization of, 9,15
 definition of, 13
 isentropic, 42,46,53
 simple, 43,58
 Fluids, cohesive, 113
 isothermal, 157
 Flux, 29
 Flux tensor, 116,118
 Force due to viscosity, 142
 Forces, external, 35
 nonlocal, 35
 Fractured diaphragm, 165

 Gas, ideal, 34,39
 isentropic, 58
 polytropic, 40,42,65,108,126
 simple, 58
 Gas constant, 35
 Gas viscosity, 113
 General solution of inverted
 equations, 109
 General solution of simple fluid, 65

 Heat, coefficient of, 122
 Heat conduction, 10,12,44
 rate of, 120
 Helmholtz instability, 187,191

Hodograph transformation, 106
 Hugoniot relation, 82
 Hydrodynamic equations, molecular derivation, 133

 Ideal gas, 34,39
 Impulsive motion of plate, 140
 Impulsive piston motion, 92
 Incompressible flow, 188
 Instability, Helmholtz, 187,191
 Taylor, 187,188
 Integral, time derivative of, 26
 Integral derivation of shock relations, 73
 Integral form of equations, 30
 Integration, along fluid motion, 18
 Interaction of shock and rarefaction, 91, 102
 Internal energy, 16,40
 behind shock, 80
 molecular definition of, 130
 Internal pressure, 34
 Inverted equations, general solution of, 109
 transformation to, 106
 Inverted hydrodynamic equations, 106
 Isentropic fluid, 42,46,53
 Isentropic gas, 58
 Isothermal fluid, 157
 Isothermal rarefaction, 159
 Isothermal shock, 160
 Isothermal sound speed, 155

 Jacobian, 26,27

 Kinetic energy, 16

 Lagrangian coordinate, 16
 Lagrangian form of equations, 10,21,26, 29,30,93
 Lagrangian shock speed, 75
 Laws, conservation, 9
 Liouville Equation, 132
 Liouville's Theorem, 131

 Mach line, 184
 Mach number, 78,86,164
 maximum behind shock, 80

 Mass, conservation of, 17,72,133,135
 Material velocity, 16
 Molecular derivation of equations, 133
 Molecular diffusion, 113
 Molecular distribution function, 130
 Molecular dynamics, 11, 13, 14, 127
 Molecular relaxation, 126
 Molecular velocity, 113
 mean, 130
 Molecule, diatomic, 124
 Molecules, collision with wall, 127
 diffusion of, 113
 velocity of, 113

 Momentum, 16
 angular, 49
 conservation of, 19,36,72,118,120, 134,136,138
 Momentum flux tensor, 116,118

 Nonlinearity of equations, 76
 Nonlocal forces, 35
 Numerical analysis, 7
 Ω_{ij} , 51
 Oblique shock, 162
 One-Dimensional flow, pseudo, 17
 true, 17

 Piston, arbitrary motion, 65
 uniformly accelerating, 68
 withdrawal from gas of, 60,66,90
 Polytropic gas, 40,42,65,108,126
 scaling, 86
 Polytropic equation of state,40, 126,136
 one-dimensional, 135
 Potential energy, 38
 Potential function, 189
 Prandtl-Meyer Flow, 182
 Pressure, 16
 dilatation, 119
 total, 119,136
 Progressive-wave solution, 57
 Propagation speed, 55

 Radiation, 150
 Rankine-Hugoniot relations, 72
 Rarefaction, 11

Rarefaction, due to piston withdrawal, 90
 interaction of shock and, 91,102
 isothermal, 159
 overtaking shock, 102
 Rates of strain, 117
 Reactive shock, 176
 Relaxation, molecular, 126
 Reynolds number, 118,142
 Rotation tensor, 52

 Scaling, 84,85,118
 polytropic, 86
 Second coefficient of viscosity, 118
 Second law of thermodynamics, 39
 Self-similar solution, 87,93
 Shell, cylindrical expansion of, 33
 Shock, 10,11,70
 always compressive, 81
 compression by, 71
 maximum from, 80
 curved, 71
 formation of, 67,69,70,75
 hitting a density discontinuity, 169
 infinite strength of, 79,80
 into fluid at rest, 77
 isothermal, 160
 oblique, 162
 production of, 11,67,75
 reactive, 176
 thickness of, in air, 152
 tube theory of, 165
 weak, 103
 Shock pressure decay rate, 102,105
 Shock pulse, decay of, 91
 Shock relations, fundamental derivation
 of, 72
 general, 74,75,77
 integral derivation of, 73
 polytropic gas, 77,78
 special cases, 77
 Shock signals, weak, 10,53
 Shock speed, 71
 Lagrangian, 75
 Shock structure, 12,70
 conduction only, 153
 theory of, 148
 viscosity only, 151
 Similarity solution, general, 87

 Similarity solution,
 for shock pulse, 93
 Similarity transformation, 86
 Simple fluid, 43,58
 definition of, 14
 Simple gas, 58
 Simple isentropic fluid, 46
 Simple wave, 63
 general solution for, 64
 Small disturbance, 53
 Smoothing, viscous, 143
 Solution, characteristic, 58,89
 example of, for viscous flow,144
 general, for $\gamma = 3$, 110,111
 of inverted equations, 109
 progressive-wave, 57
 self-similar, 87,93
 for simple wave, 64
 Sound in variable density
 atmosphere, 55
 Sound speed, 10,53,54,86
 general formula for, 55
 isothermal, 155
 viscous conducting gas, 154
 Sound waves, damping of, 156
 Specific field variables,
 definition of, 16
 Specific heat, 41
 Specific volume, 16
 Speedgraph transformation, 106
 Speed of escape, 61,67
 Speed of propagation, 55
 Speed of shock, 71
 Lagrangian, 75
 Speed of sound, 10,53,54,86
 isothermal, 155
 in viscous, conducting gas,154
 State, equation of, 9,34
 Stress, viscous, 12,13
 Stress tensor, 119,136
 Structure of shock, 12,70
 theory of, 148
 Summation convention, 51,116
 Symmetry of flux tensor, 116

 Taylor instability, 187,188
 Temperature 16,39,40
 viscosity dependence on, 114

Tensor notation, 51
 Thermodynamics, second law of, 39
 Thickness of boundary layer, 141
 Thickness of shock, 70
 in air, 152
 theory of, 148
 Total pressure, 119,136
 Transformation, Eulerian to
 Lagrangian, 22,24
 Lagrangian to Eulerian, 23
 similarity, 86
 to inverted equations, 106
 Transformation determinant, 108

 Vacuum, expansion into a, 111
 Variable density atmosphere, 55
 Variables, field, 15,73
 Velocity, 16
 angular, 44
 field, local decomposition of, 51
 material, 16
 mean molecular, 130
 of molecules, 113
 Viscosity, 10,12,44
 artificial, 150
 coefficient of, 115,118
 damping due to, 143
 force due to, 142
 gaseous, 113
 theory of, 113,146
 Viscous drag, 114
 Viscous equations, two-dimensional, 138
 Viscous flow, with acceleration, 146
 example of solution, 144
 Viscous fluid, definition of, 13
 Viscous force, 142
 Viscous smoothing, 143
 Viscous stress, 12,13
 Volume integral, time derivative of, 26
 Vorticity, 45

 Wave, simple, 63
 Wave equation, 55,56
 Weak shock, 103
 Weak signals, 10,53
 Wedge, flow past, 162
 Work done on fluid element, 120,122

 Underdriven detonation, 178